

Total Power solution of Portable Applications

800mA Charge +800mA Buck DC/DC+300mA LDO

General Description

The LP78084 is a complete constant-current/constant-voltage linear battery charger for a single-cell 4.2V lithium-ion battery with a 800mA step-down converter, and a 300mA low dropout (LDO) linear regulator. The input voltage range is 3.75V to 5.5V for the battery charger and 2.6V to 5.5V for the step-down converter and linear regulator, making it ideal for applications operating with single-cell lithium-ion/polymer batteries.

The battery charger offers an integrated pass device, reverse blocking protection, high accuracy current and voltage regulation, charge status, and charge termination. The charging current is programmable via external resistor from 15mA to 800mA. In addition to these standard features, the device offers current limit, thermal protection, and soft-start.

The step-down converter is a highly integrated converter operating at a 1.5MHz switching frequency, minimizing the size of external components while keeping switching losses low. It has independent input and enable pins. The output voltage ranges from 0.6V to the input voltage.

The LP78084 linear regulator is designed for fast transient response and good power supply ripple rejection. Designed for 300mA of load current, it includes short-circuit protection and thermal shutdown. The LP78084 is available in a 16-lead 3mm*4mm TDFN package and is rated over the -40°C to 85°C temperature range.

Order Information

LP78084 -	□	□	□	□	□	F: Pb-Free
	└──┬──┬──┬──┬──┘					
	└──┬──┬──┬──┬──┘					Package Type
	└──┬──┬──┬──┬──┘					QV: TDFN-16
	└──┬──┬──┬──┬──┘					LDO Output Voltage
	└──┬──┬──┬──┬──┘					33: 3.3V
	└──┬──┬──┬──┬──┘					30: 3.0V
	└──┬──┬──┬──┬──┘					28: 2.8V
	└──┬──┬──┬──┬──┘					18: 1.8V

Applications

- ✧ Portable Media Players/MP3 players
- ✧ Cellular and Smart mobile phone
- ✧ PDA/DSC
- ✧ Bluetooth Applications

Features

- ✧ Battery Charger:
 - Input Voltage Range : 3.75 V to 5.5V
 - Constant-Current/Constant-Voltage Operation with Thermal Feedback to Maximize Charge Rate Without Risk of Overheating
 - Internal 4.5 Hour Safety Timer for Termination
 - Charge Current Programmable Up to 800mA with 5% Accuracy
 - C/10 Charge Current Detection Output
 - 5 uA Supply Current in Shutdown Mode
- ✧ Synchronous Buck Converter:
 - Input Voltage Range: 2.6V to 5.5V
 - Output Voltage Range: 0.6V to VIN
 - 800mA Output Current
 - Up to 90% Efficiency
 - 36 uA Quiescent Current
 - 1.5MHz Switching Frequency
 - 120 uS Start-Up Time
- ✧ Linear Regulator:
 - 300mA Output Current
 - Low Dropout: 150mV at 300mA
 - Fast Line and Load Transient Response
 - High Accuracy: ± 1.5%
 - 84 uA Quiescent Current
- ✧ Short-Circuit, Over-Temperature, and Current Limit Protection
- ✧ 3mm × 4mm TDFN-16 Package
- ✧ RoHS Compliant and 100% Lead (Pb)-Free

Typical Application Circuit

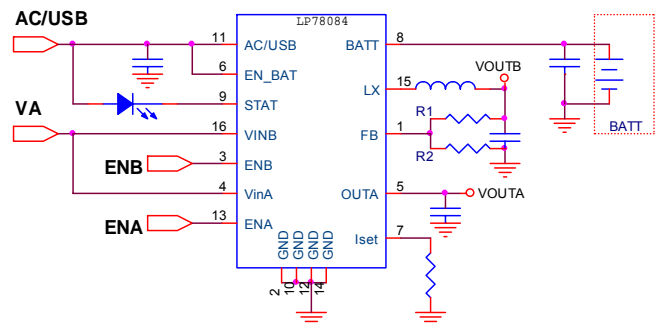

Marking Information

Please see website.

Functional Pin Description

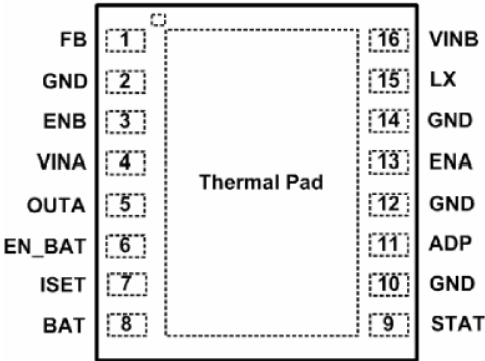
Package Type	Pin Configurations
TDFN- 16	<p>(TOP VIEW)</p> 

Pin Description

Pin	PIN	DESCRIPTION
1	FB	Feedback input. This pin must be connected directly to an external resistor divider. Nominal voltage is 0.6V.
2,10,12,14	GND	Ground.
3	ENB	Enable pin for the step-down converter. When connected to logic low, the step-down converter is disabled and consumes less than 1 μ A of current. When connected to logic high, the converter resumes normal operation.
4	VINA	Linear regulator input voltage. Connect a 1 μ F or greater capacitor from this pin to ground.
5	OUTA	Linear regulator output. Connect a 2.2 μ F capacitor from this pin to ground.
6	EN_BAT	Enable pin for the battery charger. When connected to logic low, the battery charger is disabled and consumes less than 1 μ A of current. When connected to logic high, the charger resumes normal operation.
7	ISET	Charge current set point. Connect a resistor from this pin to ground. Refer to typical characteristics curves for resistor selection.
8	BAT	Battery charging and sensing.
9	STAT	Charge status input. Open drain status output.
11	ADP	Input for USB/adapter charger.
13	ENA	Enable pin for the linear regulator. When connected to logic low, the regulator is disabled and consumes less than 1 μ A of current. When connected to logic high, it resumes normal operation.
15	LX	Output of the step-down converter. Connect the inductor to this pin. Internally, it is connected to the drain of both high- and low-side MOSFETs.
16	VINB	Input voltage for the step-down converter.

Function Block Diagram

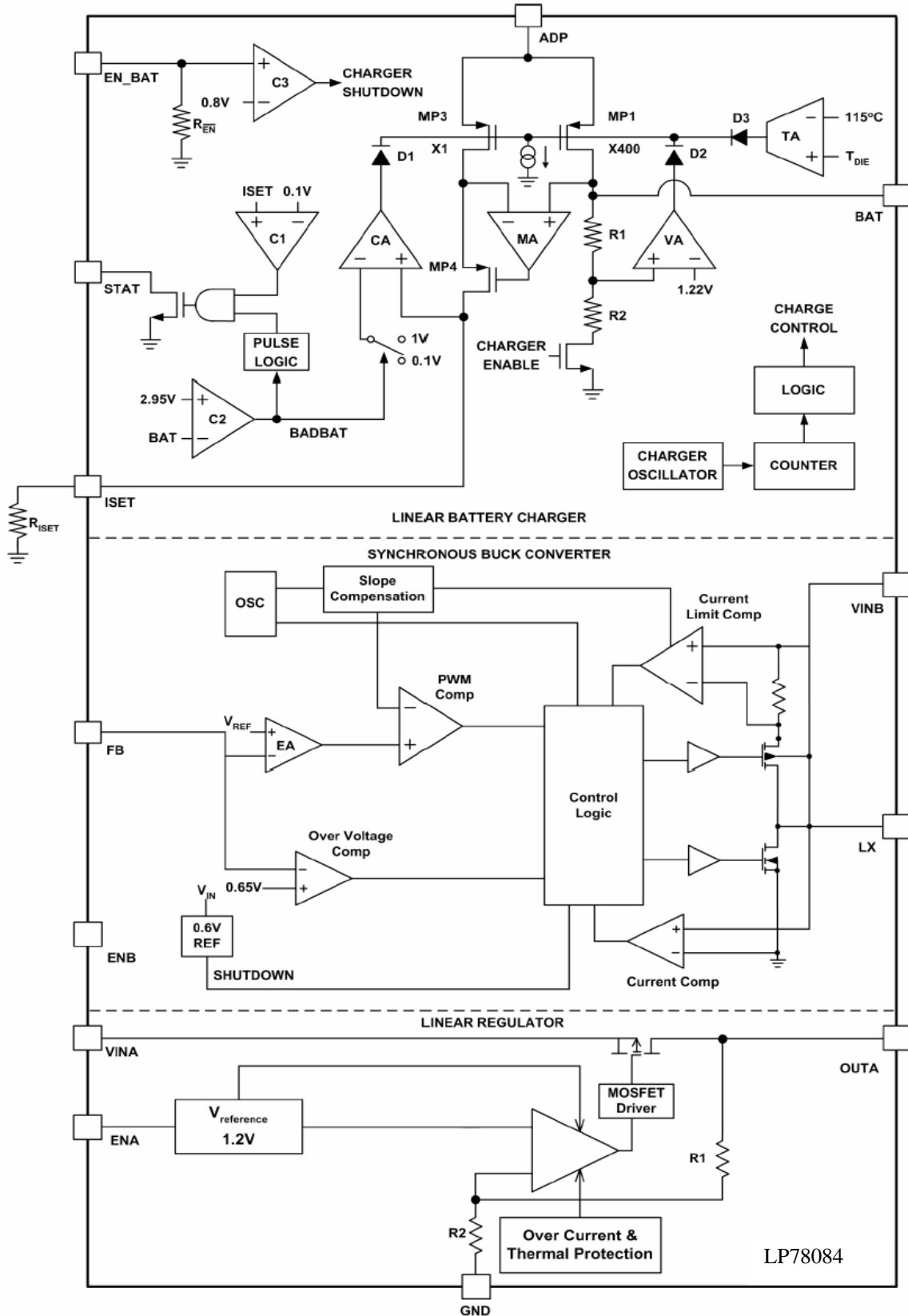

Figure 2.

Absolute Maximum Ratings

- ✧ Input Voltage to GND (V_{INA}, V_{INB}) ----- 6V
- ✧ Adapter Voltage to GND (V_{ADP}) -----0.3V to 6V
- ✧ LX to GND (V_{LX}) ----- 0.3V to $V_{IN}+0.3V$
- ✧ FB to GND (V_{FB}) ----- 0.3V to $V_{IN}+0.3V$
- ✧ ENA, ENB, EN_BAT to GND (V_{EN}) -----0.3V to 6V
- ✧ BAT, ISET, STAT (V_X) -----0.3V to $V_{ADP}+0.3V$
- ✧ Operating Junction Temperature Range (T_J) -----40°C to 150°C
- ✧ Maximum Soldering Temperature (at leads, 1 0sec) -----260°C

Thermal Information

- ✧ Maximum Power Dissipation (P_D) ----- 2W
- ✧ Thermal Resistance (J_A) -----50°C/W

Electrical Characteristics

($V_{INA}=V_{OUT(NOM)}+1V$ for v_{OUT} options greater than 1.5V. $I_{OUT}=1mA$, $C_{OUT}=2.2\mu F$, $C_{IN}=1\mu F$, $T_A=-40^\circ C$ to $85^\circ C$, unless otherwise noted. Typical values are $T_A=25^\circ C$)

Symbol	Parameter	Conditions	LP78084			Unit
			Min.	Typ.	Max.	
Step-Down Converter						
V_{IN}	Input Voltage		2.6		5.5	V
V_{UVLO}	UVLO Threshold	V_{INB} Rising			2.6	V
		Hysteresis		200		mV
		V_{INB} Falling	2.4			V
V_{OUT}	Output Voltage Tolerance	$I_{OUTB}=0$ to 250mA, $V_{INB}=2.6V$ to 5.5V	-3		3	%
V_{OUT}	Output Voltage Range		0.6		V_{INB}	V
I_Q	Quiescent Current	No Load		36		μA
I_{SHDN}	Shutdown Current	ENB = GND			1	μA
I_{LIM}	P-Channel Current Limit		1			A
$R_{DS(ON)H}$	High-Side Switch On Resistance			0.26		Ω
$R_{DS(ON)L}$	Low-Side Switch On Resistance			0.28		Ω
I_{LXLEAK}	LX Leakage Current	$V_{INB}=5.5V$, $V_{LX}=0$ to v_{INB}			1	μA
$\Delta V_{Line-reg}/\Delta V_{IN}$	Line Regulation	$V_{INB}=2.8V$ to 5.5V		0.2	0.4	%/V
V_{FB}	Feedback Threshold Voltage Accuracy	$V_{INB}=3.6V$	0.588	0.6	0.612	V
I_{FB}	FB Leakage Current	$V_{OUTB}=1.0V$			0.2	μA
F_{OSC}	Oscillator Frequency		1.2	1.5	1.8	MHz
T_S	Startup Time	From Enable to Output Regulation		120		μs
T_{SD}	Over-Temperature Shutdown Threshold			150		$^\circ C$
T_{HYS}	Over-Temperature Shutdown Hysteresis			20		$^\circ C$
$V_{EN(L)}$	Enable Threshold Low				0.4	V
$V_{EN(H)}$	Enable Threshold High		1.4			V
I_{EN}	Input Low Current	$V_{INB}=V_{ENB}=5.5V$	-1		1	μA

Electrical Characteristics ($V_{IN} = V_{OUT(NOM)} + 1V$ for V_{OUT} options greater than 1.5V. $I_{OUT} = 1mA$, $C_{OUT} = 2.2\mu F$, $C_{IN} = 1\mu F$, $T_A = -40^\circ C$ to $85^\circ C$, unless otherwise noted. Typical values are $T_A = 25^\circ C$)

Symbol	Parameter	Conditions	LP78084			Unit	
			Min.	Typ.	Max.		
Linear Regulator							
V_{OUT}	Output Voltage Tolerance	$I_{OUTA} = 100 \mu A$ to $300mA$	$T_A = 25^\circ C$	-3	3	%	
V_{IN}	Input Voltage			$V_{OUT} + V_{DO}$	5.5	V	
V_{DO}	Dropout Voltage	$I_{OUTA} = 300mA$		150	200	mV	
$\frac{\Delta V_{OUT}}{V_{OUT}} \div \Delta V_{IN}$	Line Regulation	$V_{INA} = V_{OUTA} + 0.5$ to $5.5V$, $I_{OUTA} = 1mA$		0.05	0.2	%/V	
$\Delta V_{OUT(Load)}$	Dynamic Load Regulation	$I_{OUTA} = 1mA$ to $300mA$		15	35	mV	
I_{OUT}	Output Current	$V_{OUTA} > 1.2V$		300		mA	
I_{SC}	Short-Circuit Current	$T_A = -40k$ to $85k$		720		mA	
I_Q	Quiescent Current	$V_{INA} = 5V$; $EN_A = V_{IN}$		84	140	μA	
I_{SHDN}	Shutdown Current	$V_{INA} = 5V$; $EN_A = 0V$			1	μA	
PSRR	Power Supply Rejection Ratio	$V_{IN} = V_{OUT} + 1V$	1kHz	65		dB	
T_{SD}	Over-Temperature Shutdown Threshold			160		$^\circ C$	
T_{HYS}	Over-Temperature Shutdown Hysteresis			25		$^\circ C$	
e_N	Output Noise	$I_{OUT} = 10mA$, 10Hz to 100kHz		125		μV_{RMS}	
$V_{EN(L)}$	Enable Threshold Low				0.4	V	
$V_{EN(H)}$	Enable Threshold High			1.6		V	
I_{EN}	Enable Input Current	$V_{ENA} = 5.5V$			100	nA	
Battery Charger Operation							
V_{ADP}	Adapter Voltage Range			3.75	5	5.5	V
V_{ASD}	Automatic Shutdown Threshold Voltage	$(V_{CC} - V_{BAT})$, V_{CC} Low to High		85	110	135	mV
		$(V_{CC} - V_{BAT})$, V_{CC} High to Low		15	45	70	
T_{SS_CHRG}	Battery Charger Soft-Start Time				120		μS
V_{UVLO}	Under-Voltage Lockout (UVLO)	ADP Rising Edge		3.4	3.6	3.8	V
		ADP Falling Edge		2.8	3	3.2	V
I_{OP}	Operating Current	$V_{BAT} = 4.5V$ (Forces I_{BAT} and $I_{SET} = 0$)			115	300	μA
$I_{SHUTDOWN}$	Shutdown Current	$V_{BAT} = 4V$, $EN_BAT = GND$			0.2	5	μA
$I_{LEAKAGE}$	Reverse Leakage Current from BAT Pin	$V_{BAT} = 4V$, $V_{ADP} = 3.5V$			0.7	2	μA

Electrical Characteristics ($V_{IN} = V_{OUT(NOM)} + 1V$ for V_{OUT} options greater than 1.5V. $I_{OUT} = 1mA$, $C_{OUT} = 2.2\mu F$, $C_{IN} = 1\mu F$, $T_A = -40^{\circ}C$ to $85^{\circ}C$, unless otherwise noted. Typical values are $T_A = 25^{\circ}C$)

Voltage Regulation

V_{BAT_EOC}	End of Charge Accuracy		4.158	4.200	4.242	V
$\frac{\Delta V_{BAT_EOC}}{V_{BAT_EOC}}$	Output Charge Voltage Tolerance			1		%
V_{MIN}	Preconditioning Voltage Threshold		2.80	2.95	3.10	V
V_{RCH}	Battery Recharge Voltage Threshold	Measured from V_{BAT_EOC}		-0.15		V
ΔV_{UVCL1}	(ADP - V_{BAT}) Undervoltage Current Limit Threshold Voltage	$I_{BAT} = 0.9 I_{CH}$	180	300		mV
ΔV_{UVCL2}		$I_{BAT} = 0.1 I_{CH}$	90	130		mV

Current Regulation

I_{CHG}	Charge Current Programmable Range		15		500	mA
$\frac{\Delta I_{CHG}}{I_{CHG}}$	Charge Current Regulation Tolerance			10		%
V_{ISET}	ISET Pin Voltage			1		V
K_{LA}	Current Set Factor: I_{CHG}/I_{SET}			400		
t_{TIMER}	Termination Timer		3	4.5	6	hrs
	Recharge Time		1.5	2.25	3	hrs
	Low-Battery Charge Time	$V_{BAT} = 2.5V$	0.75	1.125	1.5	hrs
f_{BADBAT}	Defective Battery Detection STAT Pulse Frequency			2		Hz
D_{BADBAT}	Defective Battery Detection STAT Pulse Frequency Duty Ratio			75		%
T_{LIM}	Junction Temperature in Constant-Temperature Mode			115		$^{\circ}C$

Charging Devices

$R_{DS(ON)}$	Charging Transistor On Resistance	$V_{ADP} = 4.2V$		1		Ω
--------------	-----------------------------------	------------------	--	---	--	----------

Logic Control / Protection

$V_{EN(H)}$	Enable Threshold High		1.6			V
$V_{EN(L)}$	Enable Threshold Low				0.4	V
V_{STAT}	Output Low Voltage	STAT Pin Sinks 4mA			0.4	V
I_{STAT}	STAT Pin Current Sink Capability				8	mA
I_{TK}/I_{CHG}	Pre-Charge Current	$I_{CHG} = 1.00mA$		10		%
I_{TERM}/I_{CHG}	Charge Termination Threshold Current			10		%

Typical Operating Characteristics

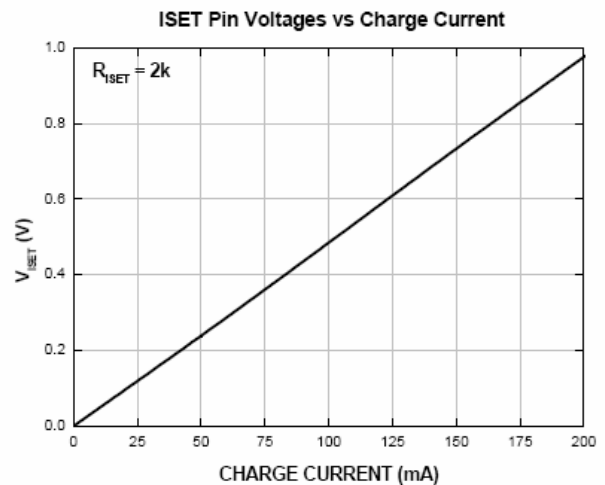
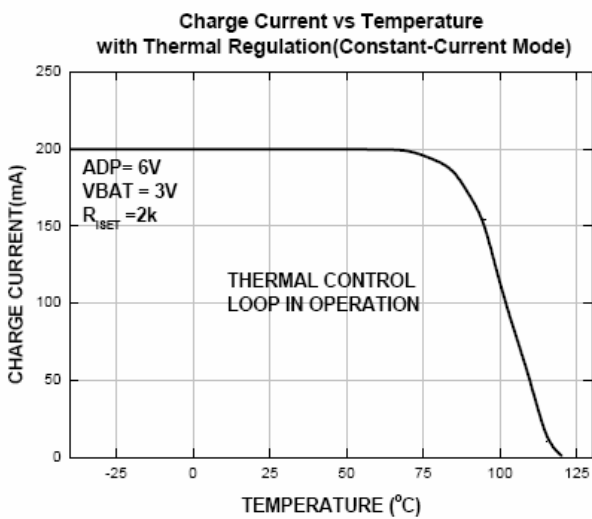
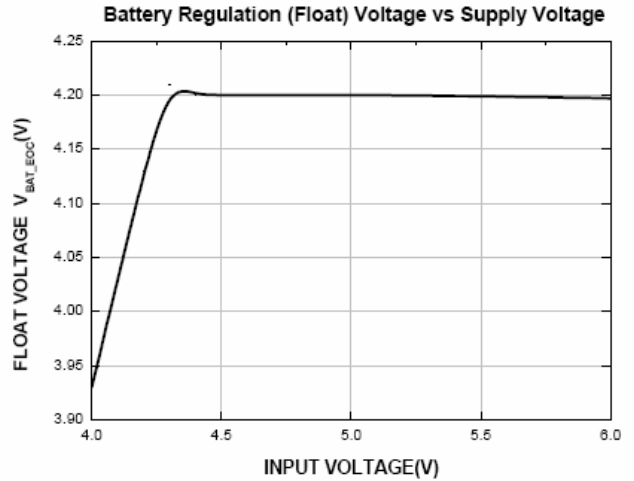
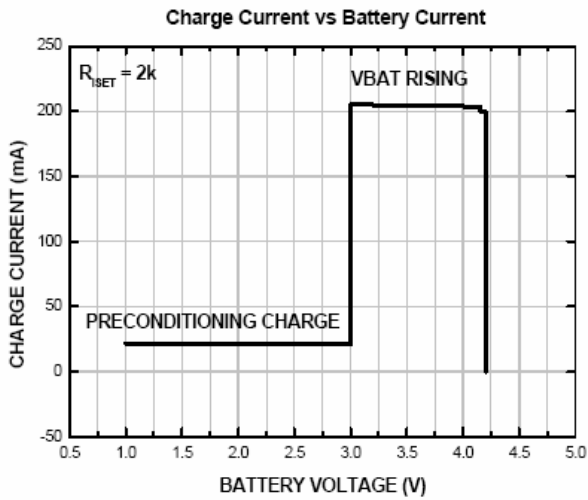
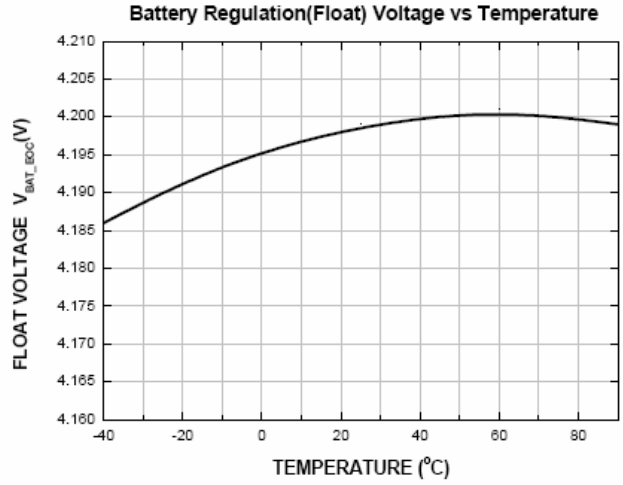
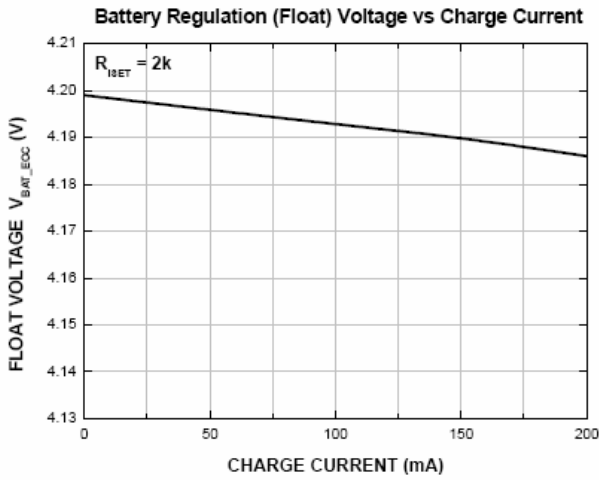

EN_BAT Pin Threshold Voltage vs Temperature

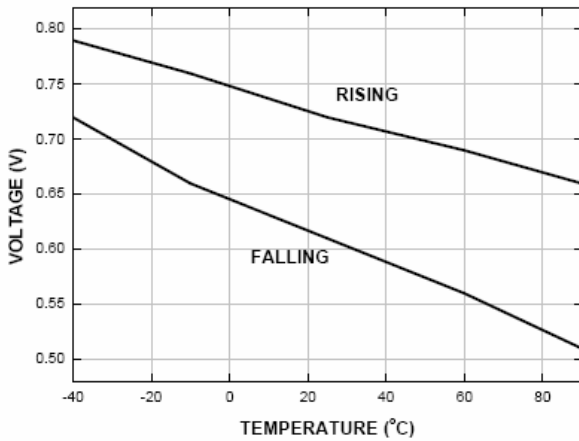

EN_BAT vs Temperature

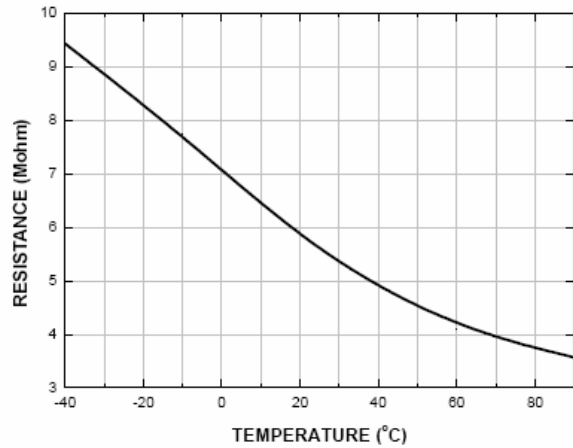

STAT Pin Output Low Voltage vs Temperature

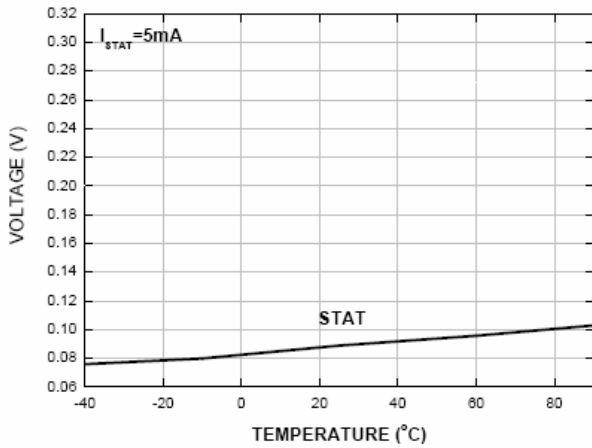

Normalized Charger Timer Period vs Temperature

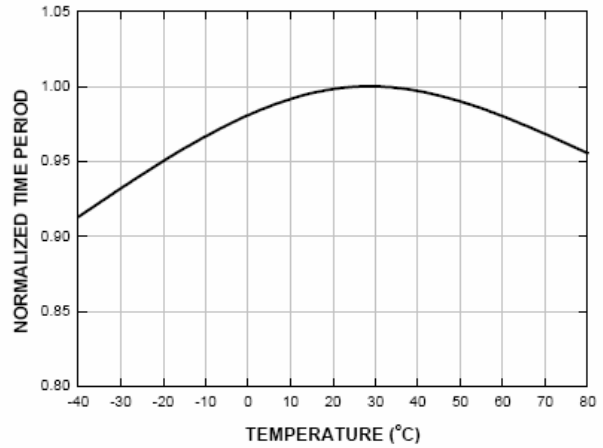

Charger FET On-Resistance vs Temperature

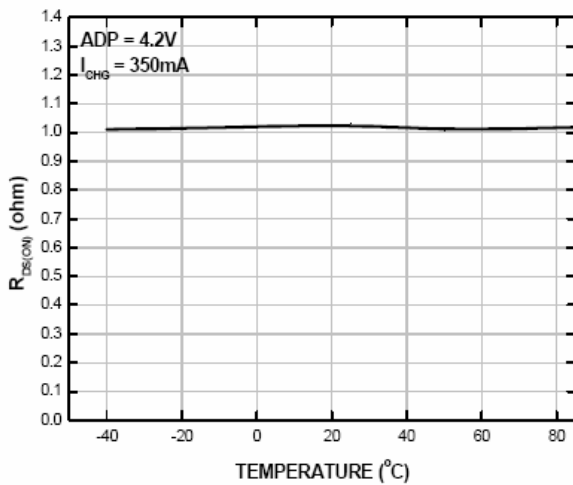

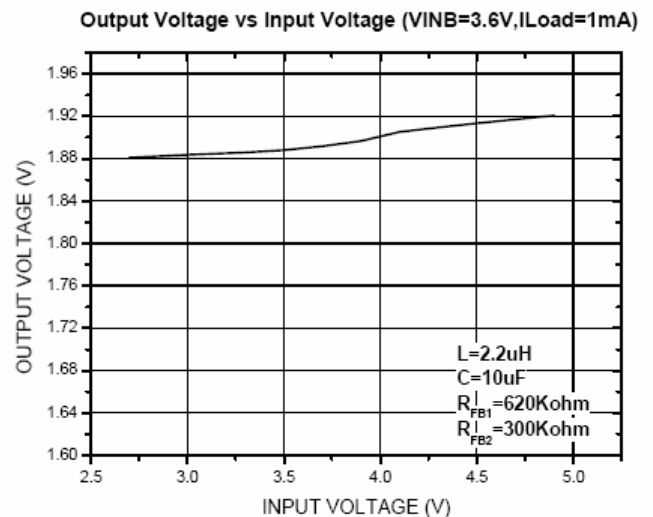
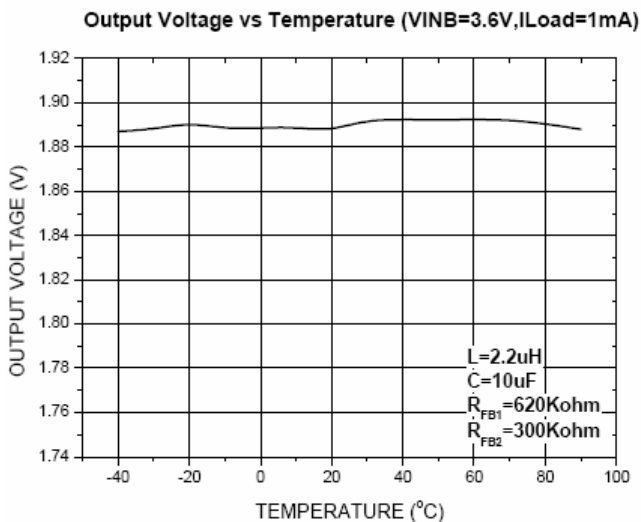
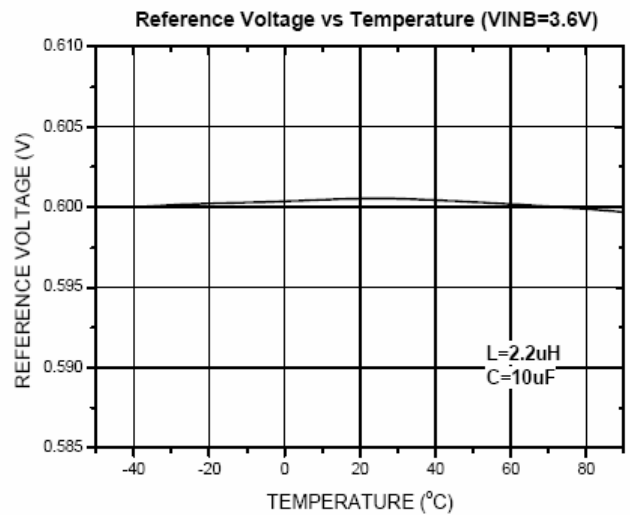
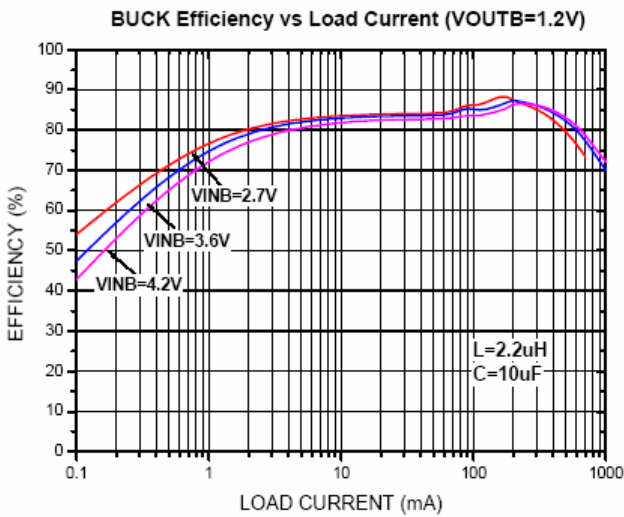
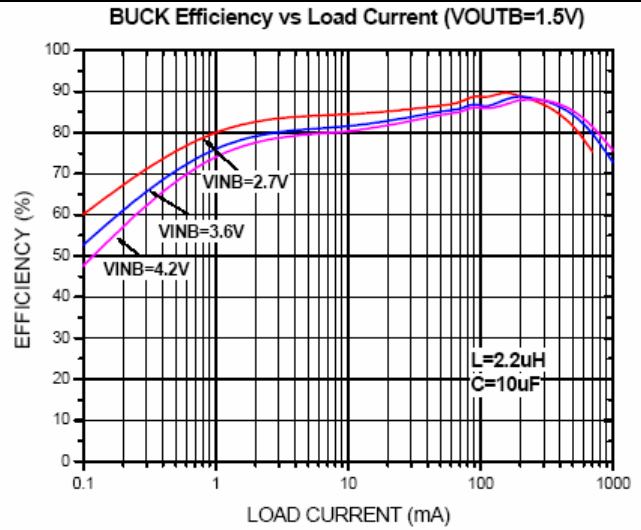
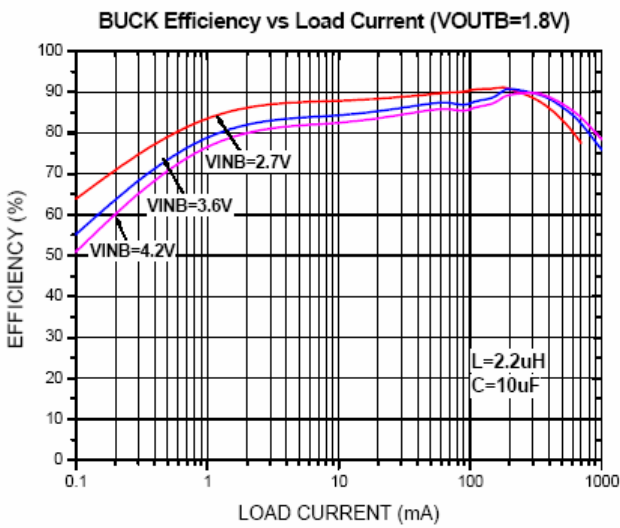

Quiescent Current vs Input Voltage (No Load)

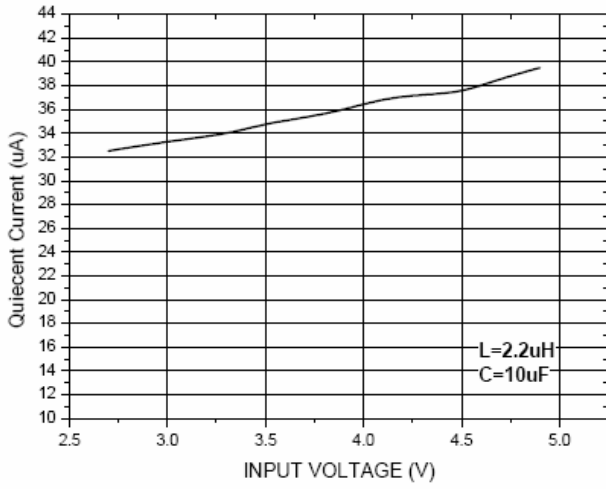

Quiescent Current vs Temperature (No Load)

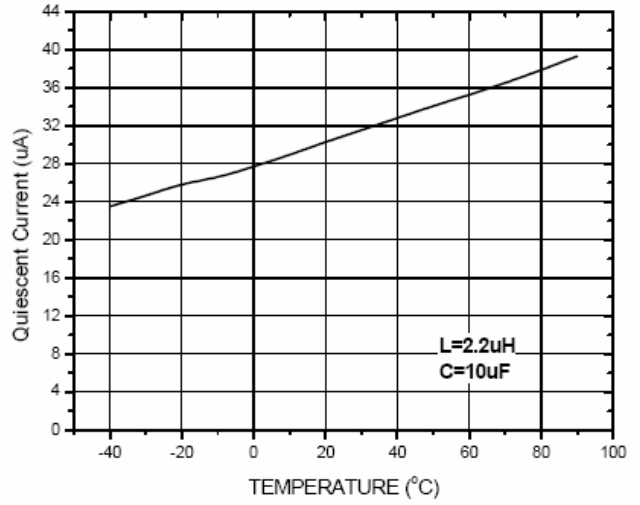

Switching Frequency vs Input Voltage

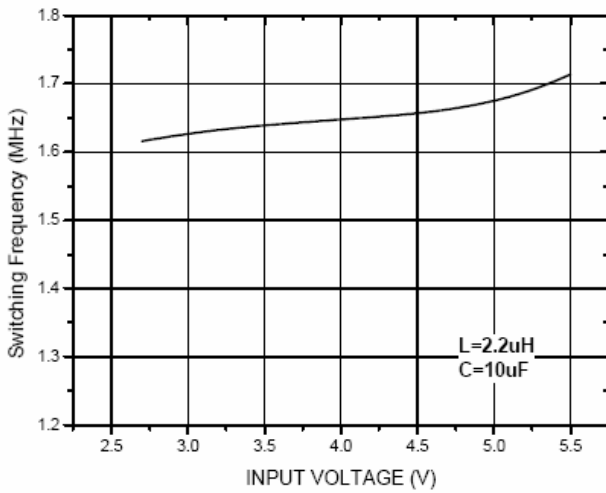

Switching Frequency vs Temperature

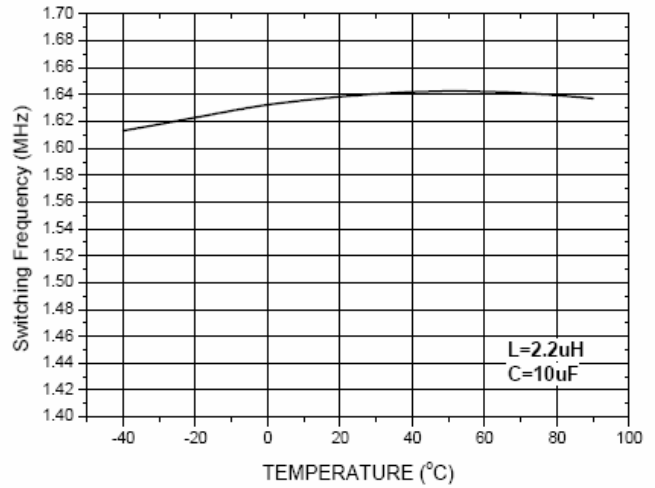

Ron(PMOS) vs Input Voltage

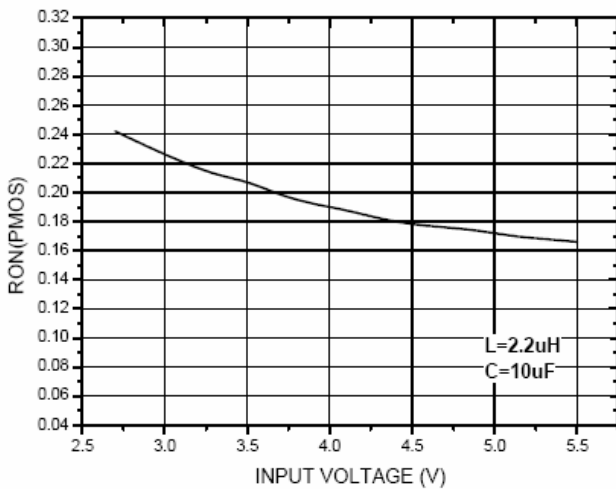

Ron(PMOS) vs Temperature

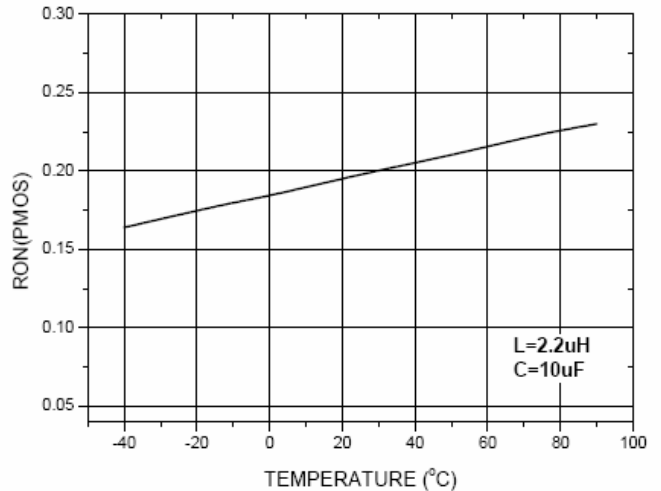

Output Voltage Transient Response (VINB=3.6V,VOUTB=1.8V,ILoad=10mA)

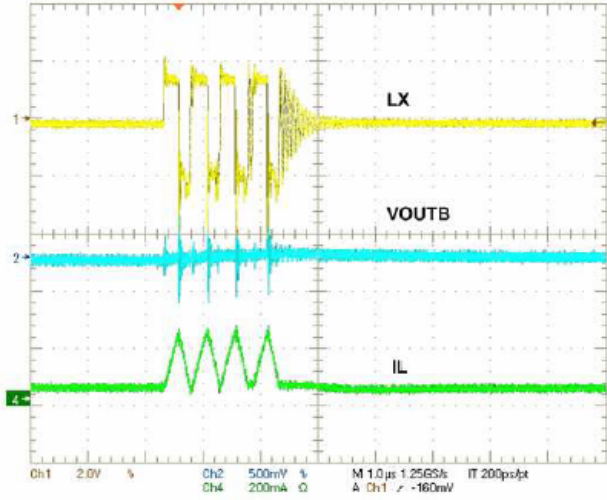

Output Voltage Transient Response (VINB=3.6V,VOUTB=1.8V,ILoad=30mA)

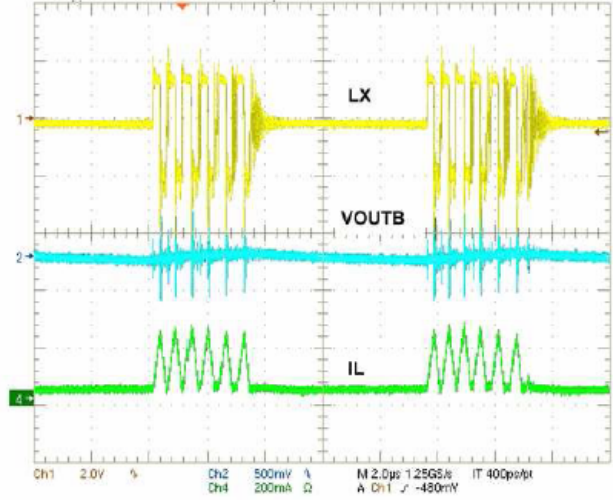

Output Voltage Transient Response (VINB=3.6V,VOUTB=1.8V,ILoad=50mA)

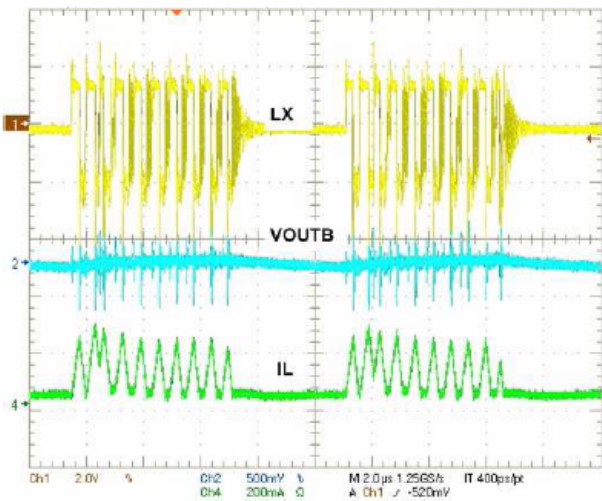

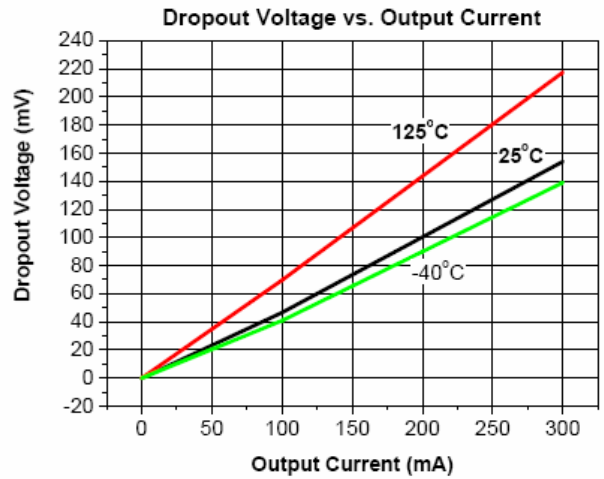
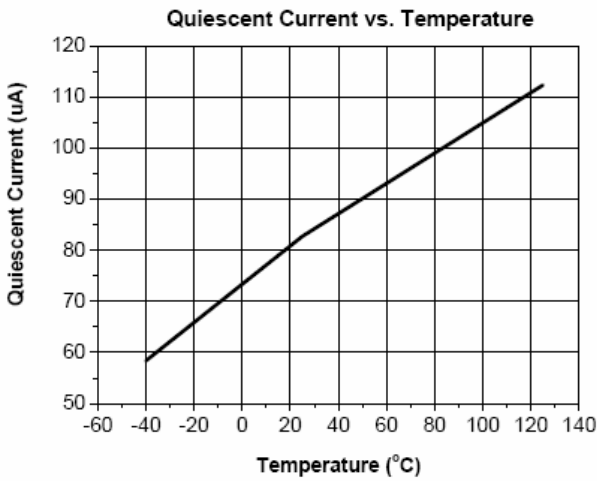
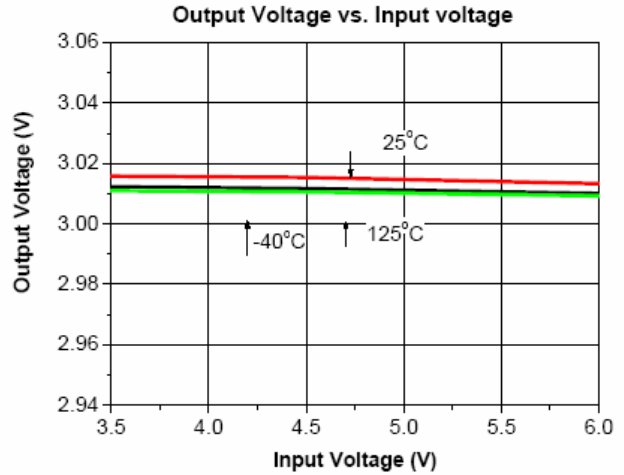
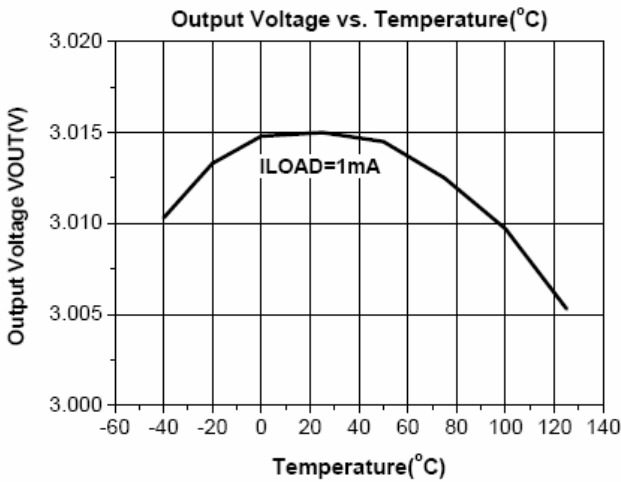

Load Transient Response (I_{Load}=1mA to 150mA)

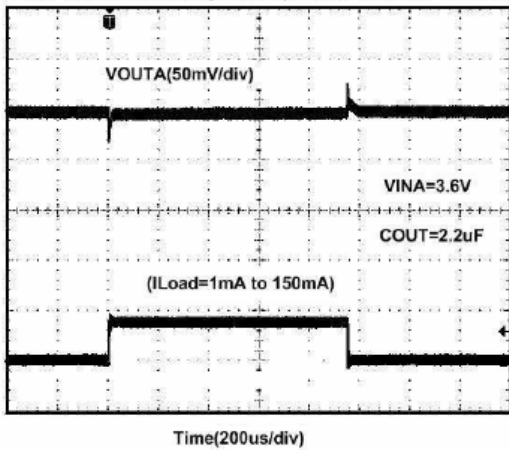

Load Transient Response (I_{Load}=1mA to 300mA)

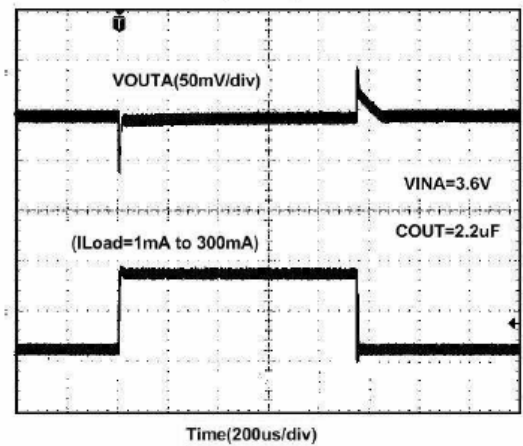

Line Transient Response (COUT=1uF)

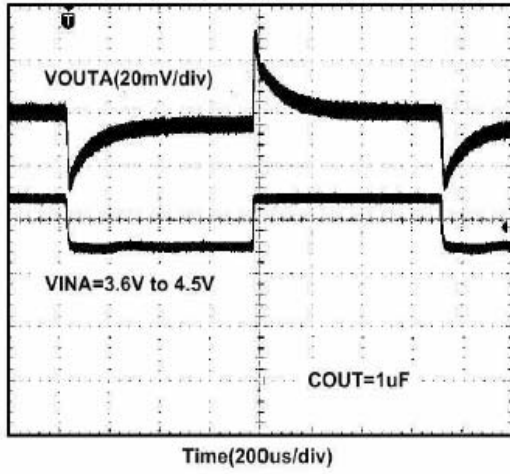

Line Transient Response (COUT=2.2uF)

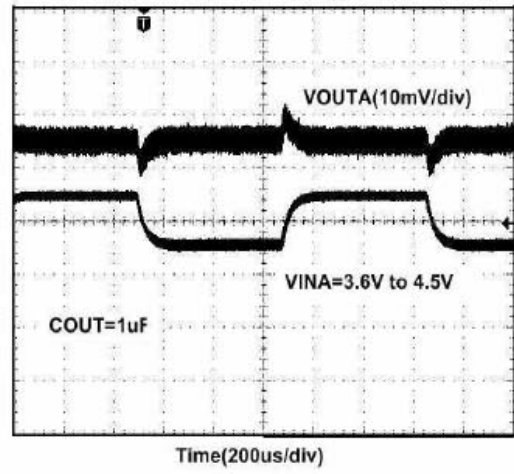

PSRR

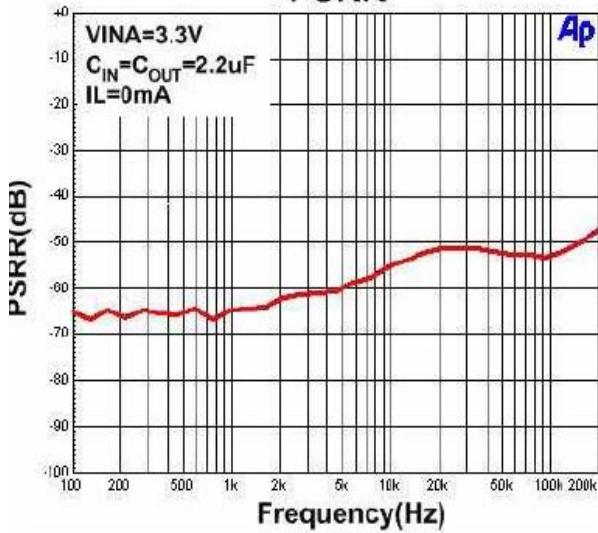

Output Noise (10Hz to 100kHz)

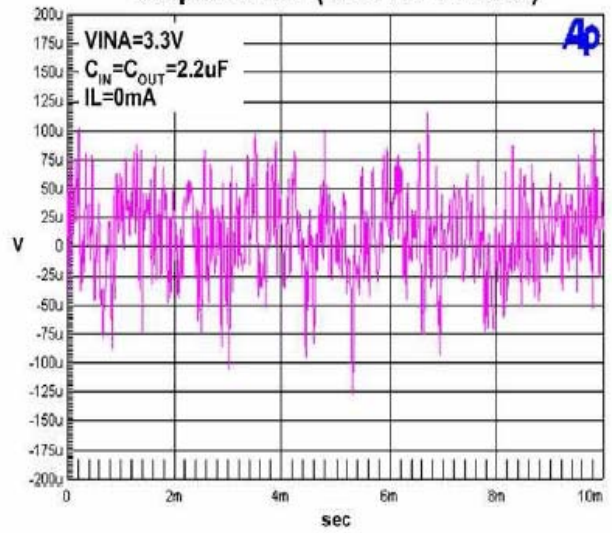

Operation

The LP78084 is a full-featured linear battery charger with an integrated synchronous buck converter, and a linear regulator designed primarily for handheld applications. The battery charger is capable of charging single-cell 4.2V Li-Ion batteries. The buck converter is powered from the VINB pin and has a programmable output voltage providing a maximum load current of 600mA. The linear regulator is design for low noise, low-dropout application. The converter, the linear regulator and the battery charger can run simultaneously or independently of each other.

BATTERY CHARGER OPERATION

Featuring an internal P-channel power MOSFET, MP1, the battery charger uses a constant-current/constant-voltage charge algorithm with programmable current. Charge current can be programmed up to 500mA with a final float voltage of $4.2V \pm 1\%$. The STAT open-drain status output indicates when C/10 has been reached. No blocking diode or external sense resistor is required; thus, the basic charger circuit requires only two external components. An internal termination timer adheres to battery manufacturer safety guidelines. Furthermore, the LP78084 battery charger is capable of operating from a USB power source.

A charge cycle begins when the voltage at the ADP pin rises above 3.6V and approximately 10mV above the BAT pin voltage, a 1% program resistor is connected from the ISET pin to ground, and the EN_BAT pin is pulled above the enable threshold (V_{IH}). If the battery voltage is less than 2.95V, the battery charger begins trickle charging at 10% of the programmed charge current.

When the BAT pin approaches the final float voltage of 4.2V, the battery charger enters constant-voltage mode and the charge current begins to decrease. When the current drops to 10% of the full-scale charge current, an internal comparator turns off the N-channel MOSFET driving the STAT pin, and the pin becomes high impedance.

An internal thermal limit reduces the programmed charge current if the die temperature attempts to rise above a preset value of approximately 115°C. This feature protects the LP78084 from excessive temperature and allows the user to push the limits of the power handling capability of a given circuit board without the risk of damaging the LP78084 or external components. Another benefit of the thermal limit is that charge current can be set according to typical, rather than worst-case, ambient temperatures for a given application with the assurance that the battery charger will automatically reduce the current in worst-case conditions.

An internal timer sets the total charge time, t_{TIMER} (typically 4.5 hours). When this time elapses, the charge cycle terminates and the STAT pin assumes a high impedance state even if C/10 has not yet been reached. To restart the charge cycle, remove the input-voltage and reapply it or momentarily force the EN_BAT pin below V_{IL} . A new charge cycle will automatically restart if the BAT pin voltage falls below V_{BAT_EOC} (typically 4.05V).

Constant-Current / Constant-Voltage / Constant-Temperature

The LP78084 battery charger uses a unique architecture to charge a battery in a constant-current, constant-voltage and constant-temperature fashion. Figure 2 shows a Simplified Block Diagram of the LP78084. Three of the amplifier feedback loops shown control the constant-current, CA, constant-voltage, VA, and constant-temperature, TA modes. A fourth amplifier feedback loop, MA, is used to increase the output impedance of the current source pair, MP1 and MP3 (note that MP1 is the internal P-channel power MOSFET). It ensures that the drain current of MP1 is exactly 400 times the drain current of MP3.

Amplifiers CA and VA are used in separate feedback loops to force the charger into constant-current or constant voltage mode, respectively. Diodes D1 and D2 provide priority to either the constant-current or constant-voltage loop, whichever is trying to reduce the charge current the most. The output of the other amplifier saturates low which effectively removes its loop from the system. When in constant-current mode, CA servos the voltage at the ISET pin to be precisely 1V. VA servos its non-inverting input to 1.22V when in constant-voltage mode and the internal resistor divider made up of R1 and R2 ensures that the battery voltage is maintained at 4.2V. The ISET pin voltage gives an indication of the charge current anytime in the charge cycle, as discussed in "Programming Charge Current" in the Applications Information section.

If the die temperature starts to creep up above 115°C due to internal power dissipation, the transconductance amplifier, TA, limits the die temperature to approximately 115°C by reducing the charge current. Diode D3 ensures that TA does not affect the charge current when the die temperature is below 115°C. In thermal regulation, the ISET pin voltage continues to give an indication of the charge current.

In typical operation, the charge cycle begins in constant-current mode with the current delivered to the battery equal to $\frac{400V}{RISET}$. If the power dissipation of the EUP8 084 results in the junction temperature approaching 115°C, the amplifier (TA) will begin decreasing the charge current to limit the die temperature to approximately 115°C. As the battery voltage rises, the LP78084 either returns to constant-current mode or enters constant-voltage mode straight from constant-temperature mode.

Battery Charger Undervoltage Lockout (UVLO)

An internal undervoltage lockout circuit monitors the input voltage and keeps the battery charger off until ADP rises above 3.6V and approximately 10mV above the BAT pin voltage. The 3.6V UVLO circuit has a built-in hysteresis of approximately 0.6V, and the 110mV automatic shutdown threshold has a built-in hysteresis of approximately 65 mV. During undervoltage lockout conditions, maximum battery drain current is 5 uA and maximum supply current is 10 uA.

Undervoltage Charge Current Limiting (UVCL)

The battery charger in the LP78084 includes undervoltage charge current limiting that prevents full charge current until the input supply voltage reaches approximately 300mV above the battery voltage (ΔV_{uvcl1}). This feature is particularly useful if the LP78084 is powered from a supply with long leads (or any relatively high output impedance). See Applications Information section for further details.

Trickle Charge and Defective Battery Detection

At the beginning of a charge cycle, if the battery voltage is below 2.95V, the battery charger goes into trickle charge mode, reducing the charge current to 10% of the programmed current. If the low battery voltage persists for one quarter of the total time (1.125 hr), the battery is assumed to be defective, the charge cycle terminates and the STAT pin output pulses at a frequency of 2Hz with a 75% duty cycle. If, for any reason, the battery voltage rises above 2.95V, the charge cycle will be restarted. To restart the charge cycle (i.e., when the dead battery is replaced with a discharged battery less than 2.95V), the charger must be reset by removing the input voltage and reapplying it or temporarily pulling the EN_BAT pin below the enable threshold.

Battery Charger Shutdown Mode

The LP78084's battery charger can be disabled by pulling the EN_BAT pin below the shutdown threshold (V_{IL}). In shutdown mode, the battery drain current is reduced to less than 2 A and the ADP supply current to about 5 A provided the regulator is off. When the input voltage is not present, the battery charger is in shutdown and the battery drain current is less than 5 A.

STAT Status Output Pin

The charge status indicator pin has three states: pulldown, pulse at 2Hz (see Defective Battery Detection) and high impedance. The pulldown state indicates that the battery charger is in a charge cycle. A high impedance state indicates that the charge current has dropped below 10% of the full-scale current or the battery charger is disabled. When the timer runs out (4.5 hrs), the STAT pin is also forced to the high impedance state. If the battery charger is not in constant-voltage mode when the charge current is forced to drop below 10% of the full-scale current by UVCL, STAT will stay in the strong pulldown state.

Charge Current Soft-Start and Soft-Stop

The LP78084's battery charger includes a soft-start circuit to minimize the inrush current at the start of a charge cycle. When a charge cycle is initiated, the charge current ramps from zero to full-scale current over a period of approximately 120 μ S. Likewise, internal circuitry slowly ramps the charge current from full-scale to zero when the battery charger is turned off or self terminates. This has the effect of minimizing the transient current load on the power supply during start-up and charge termination.

Timer and Recharge

The LP78084's battery charger has an internal termination timer that starts when the input voltage is greater than the undervoltage lockout threshold and at least 110mV above BAT, and the battery charger is leaving shutdown.

At power-up or when exiting shutdown, the charge time is set to 4.5 hours. Once the charge cycle terminates, the battery charger continuously monitors the BAT pin voltage using a comparator with a 2ms filter time. When the average battery voltage falls below 4.05V (which corresponds to 80%-90% battery capacity), a new charge cycle is initiated and a 2.25 hour timer begins. This ensures that the battery is kept at, or near, a fully charged condition and eliminates the need for periodic charge cycle initiations. The STAT output assumes a strong pulldown state during recharge cycles until C/10 is reached or the recharge cycle terminates.

SWITCHING REGULATOR OPERATION:

The switching regulator in the LP78084 can be turned on by pulling the ENB pin above V_{IH} .

Main Control Loop

The switching uses a slop-compensated constant frequency, current mode PWM architecture. Both the main (P-Channel MOSFET) and synchronous (N-channel MOSFET) switches are internal. During normal operation, the buck converter regulates output voltage by switching at a constant frequency and then modulating the power transferred to the load each cycle using PWM comparator. It sums three weighted differential signals: the output feedback voltage from an external resistor divider, the main switch current sense, and the slope-compensation ramp. It modulates output power by adjusting the inductor-peak current during the first half of each cycle. An N-channel, synchronous switch turns on during the second half of each cycle (off time). When the inductor current starts to reverse or when the PWM reaches the end of the oscillator period, the synchronous switch turns off. This keep excess

current from flowing backward through the inductor, from the output capacitor to GND, or through the main and synchronous switch to GND.

Switching Regulator Undervoltage Lockout

Whenever V_{INB} is less than 2.6V, an undervoltage lockout circuit keeps the regulator off, preventing unreliable operation. However, if the regulator is already running and the battery voltage is dropping, the undervoltage comparator does not shut down the regulator until V_{INB} drops below 2.4V.

Thermal Consideration

To avoid the switching regulator from exceeding the maximum junction temperature, the user will need to do a thermal analysis. The goal of the thermal analysis is to determine whether the operating conditions exceed the maximum junction temperature of the part. The temperature rise is given by:

$$T_R = (P_D)(\theta_{JA})$$

Where $P_D = I_{LOAD}^2 \times R_{DS(ON)}$ is the power dissipated by the regulator ; θ_{JA} is the thermal resistance from the junction of the die to the ambient temperature.

The junction temperature, T_J , is given by:

$$T_J = T_A + T_R$$

Where T_A is the ambient temperature.

T_J should be below the maximum junction temperature of 150°C.

Linear Regulator Operation:

The LP78084 includes a low-noise, low-dropout, linear regulator operates from a 2.5V to 5.5V input and is guaranteed to deliver 300mA.

The linear regulator is stable with small 2.2µF ceramic capacitor. Its performance suits battery powered applications because of its shutdown mode, low quiescent current, and very low dropout voltage. The low dropout voltage allows for more utilization of a battery’s available energy by operating closer to its end-of-life voltage.

**APPLICATIONS INFORMATION
BATTERY CHARGER**

Programming Charge Current

The battery charge current is programmed using a single resistor from the ISET pin to ground. The charge current is 400 times the current out of the ISET pin. The program resistor and the charge current are calculated using the following equations:

$$R_{ISET} = 400 \times \frac{IV}{I_{CHG}} \quad I_{CHG} = 400 \times \frac{IV}{R_{ISET}}$$

The charge current out of the BAT pin can be determined at any time by monitoring the ISET pin voltage and using the following equation:

$$I_{CHG} = \frac{V_{ISET}}{R_{ISET}} \times 400$$

Stability Considerations

The LP78084 battery charger contains two control loops: constant-voltage and constant-current. The constant-voltage loop is stable without any compensation when a battery is connected with low impedance leads. Excessive lead length, however, may add enough series inductance to require a bypass capacitor of at least 1 F from BAT to GND.

In constant-current mode, the ISET pin voltage is in the feedback loop, not the battery voltage. Because of the additional pole created by ISET pin capacitance, capacitance on this pin must be kept to a minimum. With no additional capacitance on the ISET pin, the battery charger is stable with ISET resistor values as high as 25k. However, additional capacitance on this node reduces the maximum allowed program resistor. The pole frequency at the ISET pin should be kept above 100kHz. Therefore, if the ISET pin is loaded with a capacitance, C_{ISET} , the following equation should be

used to calculate the maximum resistance value for R_{ISET} :

$$R_{ISET} \leq \frac{1}{2\pi \times 10^5 \times C_{ISET}} \times 10^3$$

Average, rather than instantaneous, battery current may be of interest to the user. For example, when the switching regulator operating in low-current mode is connected in parallel with the battery, the average current being pulled out of the BAT pin is typically of more interest than the instantaneous current pulses. In such a case, a simple RC filter can be used on the ISET pin to measure the average battery current as shown in Figure 3. A 10k resistor has been added between the ISET pin and the filter capacitor to ensure stability.

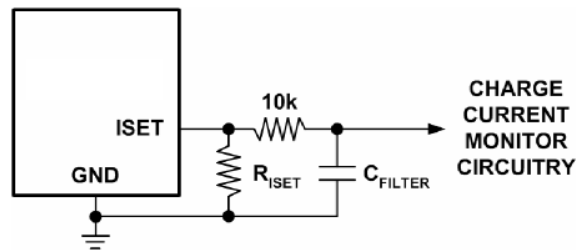

Figure 3. Isolating Capacitive Load on ISET Pin and Filtering

Undervoltage Charge Current Limiting (UVCL)

USB powered systems tend to have highly variable source impedances (due primarily to cable quality and length). A transient load combined with such impedance can easily trip the UVLO threshold and turn the battery charger off unless undervoltage charge current limiting is implemented.

Consider a situation where the LP78084 is operating under normal conditions and the input supply voltage begins to sag (e.g. an external load drags the input supply down). If the input voltage reaches V_{UVCL} (approximately 300mV above the battery voltage, ΔV_{UVCL}), under-voltage charge current limiting will begin to reduce the charge current in an attempt to maintain ΔV_{UVCL} between ADP and BAT. The LP78084 will continue to operate at the reduced charge current until the input supply voltage is increased or voltage mode reduces the charge current further.

Operation from Current Limited Wall Adapter

By using a current limited wall adapter as the input supply, the LP78084 can dissipate significantly less power when programmed for a current higher than the limit of the supply.

Consider a situation where an application requires a 200mA charge current for a discharged 800mAh Li-Ion battery. If a typical 5V (non-current limited) input supply is available then the peak power dissipation inside the part can exceed 300mW.

Now consider the same scenario, but with a 5V input supply with a 200mA current limit. To take advantage of the supply,

it is necessary to program the LP78084 to charge at a current greater than 200mA. Assume that the LP78084 charger is programmed for 300mA (i.e., $R_{ISET} = 1.33k$) to ensure that part tolerances maintain a programmed current higher than 200mA. Since the battery charger will demand a charge current higher than the current limit of the input supply, the supply voltage will collapse to the battery voltage plus 200mA times the on-resistance of the internal PMOSFET. The on-resistance of the battery charger power device is approximately 1 with a 5V supply. The actual on-resistance will be slightly higher due to the fact that the input supply will have collapsed to less than 5V. The

power dissipated during this phase of charging is approximately 40mW. That is a ten times improvement over the non-current limited supply power dissipation.

USB and Wall Adapter Power

Although the LP78084 allows charging from a USB port, a wall adapter can also be used to charge Li-Ion batteries. Figure 4 shows an example of how to combine wall adapter and USB power inputs. A P-channel MOSFET, MP 1, is used to prevent back conducting into the USB port when a wall adapter is present and Schottky diode, D1, is used to prevent USB power loss through the 1k pulldown resistor.

Typically a wall adapter can supply significantly more current than the current-limited USB port. Therefore, an N-channel MOSFET, MN 1, and an extra program resistor can be used to increase the charge current when the wall adapter is present.

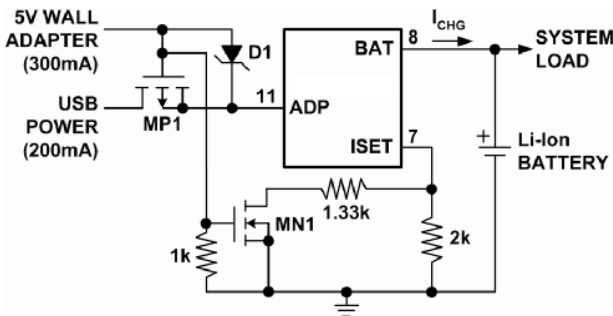

Figure 4. Combining Wall Adapter and USB Power

Power Dissipation

The conditions that cause the LP78084 battery charger to reduce charge current through thermal feedback can be approximated by considering the total power dissipated in the IC. For high charge currents, the LP78084 power dissipation is approximately:

$$P_D = (V_{ADP} - V_{BAT}) \times I_{CHG} + P_{D_BUCK} + (V_{INA} - V_{OUTA}) \times I_{OUTA}$$

Where P_D is the total power dissipated within the IC, V_{ADP} is the input supply voltage, V_{BAT} is the battery voltage, I_{BAT} is the charge current and P_{D_BUCK} is the power dissipation

due to the regulator. P_{D_BUCK} can be calculated as:

$$P_{D_BUCK} = V_{OUTB} \times I_{OUTB} \left(\frac{1}{\eta} - 1 \right)$$

Where V_{OUTB} is the regulated output of the switching regulator, I_{OUTB} is the regulator load and η is the regulator efficiency at that particular load.

It is not necessary to perform worst-case power dissipation scenarios because the LP78084 will automatically reduce the charge current to maintain the die temperature at approximately 115°C. However, the approximate ambient temperature at which the thermal feedback begins to protect the IC is:

$$T_A = 115^\circ C - P_D \theta_{JA}$$

$$T_A = 115^\circ C - (V_{ADP} - V_{BAT}) \times I_{CHG} \times \theta_{JA}$$

if the regulator is off.

Example: Consider the extreme case when an LP78084 is operating from a 6V supply providing 250mA to a 3V Li-Ion battery, the switching regulator and the LDO are off. The ambient temperature above which the LP78084 will begin to reduce the 250mA charge current is approximately: (Correctly soldered to a 2500mm² double-sided 1 oz. copper board, the LP78084 has a thermal resistance of approximately 43°C/W.)

$$T_A = 115^\circ C - (6V - 3V) \times (250mA) \times 43^\circ C/W$$

$$T_A = 115^\circ C - 0.75W \times 43^\circ C/W = 115^\circ C - 32.25^\circ C$$

$$T_A = 82.75^\circ C$$

If there is more power dissipation due to the switching regulator or the LDO, the thermal regulation will kick in at a somewhat lower temperature than this. In the above circumstances, the LP78084 can be used above 82.75°C, but the charge current will be reduced from 250mA. The approximate current at a given ambient temperature can be calculated:

$$I_{CHG} = \frac{115^\circ C - T_A}{(V_{ADP} - V_{BAT}) \times \theta_{JA}}$$

Using the previous example with an ambient temperature of 85°C, the charge current will be reduced to approximately:

$$I_{CHG} = \frac{115^\circ C - 85^\circ C}{(6V - 3V) \times 43^\circ C/W} = \frac{30^\circ C}{129^\circ C/A} = 232.6mA$$

Note: 1V = 1J/C = 1W/A

Furthermore, the voltage at the ISET pin will change proportionally with the charge current as discussed in the Programming Charge Current section.

ADP Bypass Capacitor

Many types of capacitors can be used for input bypassing; however, caution must be exercised when using multi-layer ceramic capacitors. Because of the self-resonant and high Q characteristics of some types of ceramic capacitors, high voltage transients can be generated under some start-up conditions, such as connecting the battery charger input to a live power source.

SWITCHING REGULATOR

Inductor Selection

The output inductor is selected to limit the ripple current to some predetermined value, typically 20%~40% of the full load current at the maximum input voltage. Large value inductors lower ripple currents. Higher V_{IN} or V_{OUT} also increases the ripple current as shown in equation. A reasonable starting point for setting ripple current is $I_L=240mA$ (40% of 600mA).

$$\Delta I_L = \frac{1}{(f)(L)} V_{OUT} \left(1 - \frac{V_{OUT}}{V_{IN}} \right)$$

The DC current rating of the inductor should be at least equal to the maximum load current plus half the ripple current to prevent core saturation. Thus, a 720mA rated inductor should be enough for most applications (600mA+120mA). For better efficiency, choose a low DC-resistance inductor.

C_{IN} and C_{OUT} Selection

In continuous mode, the source current of the top MOSFET is a square wave of duty cycle V_{OUT}/V_{IN} . The primary function of the input capacitor is to provide a low impedance loop for the edges of pulsed current drawn by the LP78084. A low ESR input capacitor sized for the maximum RMS current must be used. The size required will vary depending on the load, output voltage and input voltage source impedance characteristics. A typical value is around 4.7 μF .

The input capacitor RMS current varies with the input voltage and the output voltage. The equation for the maximum RMS current in the input capacitor is:

$$I_{RMS} = I_O \times \sqrt{\frac{V_O}{V_{IN}} \times \left(1 - \frac{V_O}{V_{IN}} \right)}$$

The output capacitor C_{OUT} has a strong effect on loop stability. The selection of C_{OUT} is driven by the required effective series resistance (ESR).

ESR is a direct function of the volume of the capacitor; that is, physically larger capacitors have lower ESR. Once the ESR requirement for C_{OUT} has been met, the RMS current rating generally far exceeds the $I_{RIPPLE(P-P)}$ requirement. The output ripple V_{OUT} is determined by:

$$\Delta V_{OUT} \cong \Delta I_L \left(ESR + \frac{1}{8fC_{OUT}} \right)$$

When choosing the input and output ceramic capacitors, choose the X5R or X7R dielectric formulations. These dielectrics have the best temperature and voltage characteristics of all the ceramics for a given value and size.

Output Voltage Programming

The output voltage is set by a resistive divider according to the following formula:

$$V_{OUT} = 0.6V \left(1 + \frac{R_{FB1}}{R_{FB2}} \right)$$

The external resistive divider is connected to the output, allowing remote voltage sensing as shown in Figure 5.

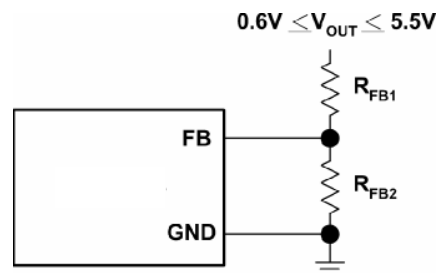

Figure 5.

LINEAR REGULATOR

External Capacitors

Like any low-dropout regulator, the regulator requires external capacitors for regulator stability. The regulator is specifically designed for portable applications requiring minimum board space and smallest components. These capacitors must be correctly selected for good performance.

Input Capacitor

A minimum input capacitance of 1 μF is required between the regulator input pin and ground (the amount of the capacitance may be increased without limit). This capacitor must be located a distance of not more than 1cm from the input pin and returned to a clean analog ground.

Any good quality ceramic, tantalum, or film capacitor may be used at the input. If a tantalum capacitor is used at the input, it must be guaranteed by the manufacturer to have a surge current rating sufficient for the application.

No-Load Stability

The regulator will remain stable and in regulation with no external load. This is specially important in CMOS RAM keep-alive applications.

Output Capacitance

The regulator is specifically designed to employ ceramic output capacitors as low as 2.2 μF . Ceramic capacitors below 10 μF offer significant cost and space savings, along with high frequency noise filtering. Higher values and other types and of capacitor may be used, but their equivalent series resistance (ESR) should be maintained below 0.5. Ceramic capacitor of the value required by the regulator are available in the following dielectric types: Z5U, Y5V, X5R, and X7R. The Z5U and Y5V types exhibit a 50% or more

drop in capacitance value as their temperature increase from 25°C, an important consideration. The X5R generally maintain their capacitance value within $\pm 20\%$. The X7R type are desirable for their tighter tolerance of 10% over temperature.

Power Dissipation and Junction Temperature

Specified regulator operation is assured to a junction temperature of 160°C; the maximum junction temperature should be restricted to 160°C under normal operating conditions. This restriction limits the power dissipation the regulator can handle in any given application. To ensure the junction temperature is within acceptable limits, calculate the maximum allowable dissipation, $P_{D(max)}$, and the actual dissipation, P_D , which must be less than or equal to $P_{D(max)}$.

The maximum-power-dissipation limit is determined using the following equation:

$$P_{D(max)} = \frac{T_{Jmax} - T_A}{R_{\theta JA}}$$

Where:

T_{Jmax} is the maximum allowable junction temperature. $R_{\theta A}$ is the thermal resistance junction-to-ambient for the package

T_A is the ambient temperature.

The regulator dissipation is calculated using:

$$P_D = (V_{INA} - V_{VOUTA}) \times I_{OUTA}$$

Power dissipation resulting from quiescent current is negligible. Excessive power dissipation triggers the thermal protection circuit.

Packaging Information

TDFN-16

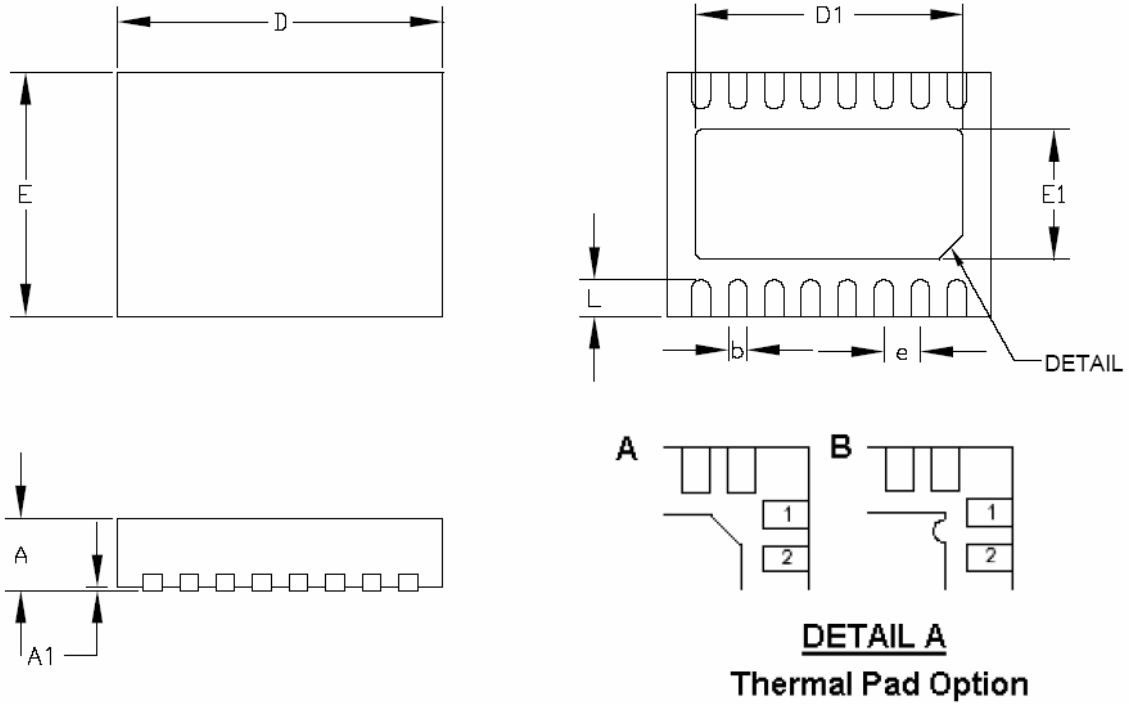

SYMBOLS	MILLIMETERS		INCHES	
	MIN.	MAX.	MIN.	MAX.
A	0.70	0.80	0.028	0.031
A1	0.00	0.05	0.000	0.002
b	0.15	0.30	0.006	0.012
E	2.90	3.10	0.114	0.122
D	3.90	4.10	0.153	0.161
D1	3.20		0.126	
E1	1.60		0.063	
e	0.45		0.018	
L	0.35	0.55	0.014	0.022