

200mA, Dual Channel Ultra-Fast CMOS LDO Regulator

General Description

The LP2201 is a dual channel, low noise, and low dropout regulator sourcing up to 250mA at each channel. The range of output voltage is from 1.2V to 3.6V by operating from 2.5V to 5.5V input.

LP2201 offers 2% accuracy, extremely low dropout voltage (80mV @ 150mA), and extremely low ground current, only 25µA per LDO. The shutdown current is near zero current which is suitable for battery-power devices. Other features include current limiting, over temperature, output short circuit protection.

LP2201 is short circuit thermal folded back protected. LP2201 lowers its OTP trip point from 165°C to 110°C when output short circuit occurs ($V_{OUT} < 0.4V$) providing maximum safety to end users.

LP2201 can operate stably with very small ceramic output capacitors, reducing required board space and component cost. LP2201 is available in fixed output voltages in the SOT-23-6 package.

Ordering Information

LP2201 -	□ □	□ □	□
	F: Pb-Free		
	Package Type		
	B6: SOT23-6		
	Out1/Out2 Voltage Type		
	18/28: 1.8V/2.8V		
	18/33: 1.8V/3.3V		
	25/28: 2.5V/2.8V		
	28/28: 2.8V/2.8V		
	28/12: 2.8V/1.2V		
	28/33: 2.8V/3.3V		
	30/30: 3.0V/3.0V		
	30/33: 3.0V/3.3V		
	33/33: 3.3V/3.3V		

Features

- ◆ Wide Operating Voltage Ranges : 2.5V to 5.5V
- ◆ Low-Noise for RF Application
- ◆ High PSRR 65dB at 1kHz
- ◆ No Noise Bypass Capacitor Required
- ◆ Fast Response in Line/Load Transient
- ◆ TTL-Logic-Controlled Shutdown Input
- ◆ Dual LDO Outputs (200mA/200mA)
- ◆ High Output Accuracy 2%
- ◆ Ultra-low Quiescent Current 27uA
- ◆ Thermal Shutdown Protection
- ◆ Thermal Shutdown Protection
- ◆ Tiny SOT-23-6 Package
- ◆ RoHS Compliant and 100% Lead (Pb)-Free

Applications

- ✧ CDMA/GSM Cellular Handsets
- ✧ Smart mobile phone
- ✧ Battery-Powered Equipment
- ✧ DSC Sensor
- ✧ Wireless Card

Pin Configurations

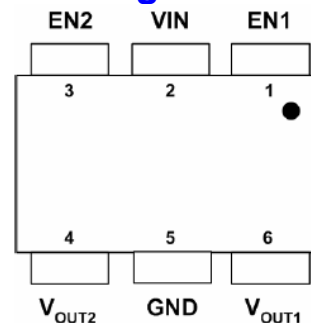

SOT23-6 (Top View)

Typical Application Circuit

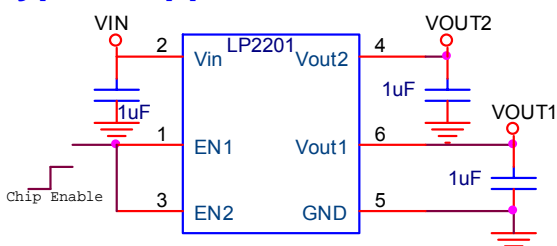

Marking Information

Please see website.

Functional Pin Description

Pin No.	Pin Name	Pin Function
1	EN1	Chip Enable1 (Active High)
2	VIN	Supply Input
3	EN2	Chip Enable2 (Active High)
4	VOUT2	Channel 2 Output Voltage
5	GND	Common Ground
6	VOUT1	Channel 1 Output Voltage

Function Block Diagram

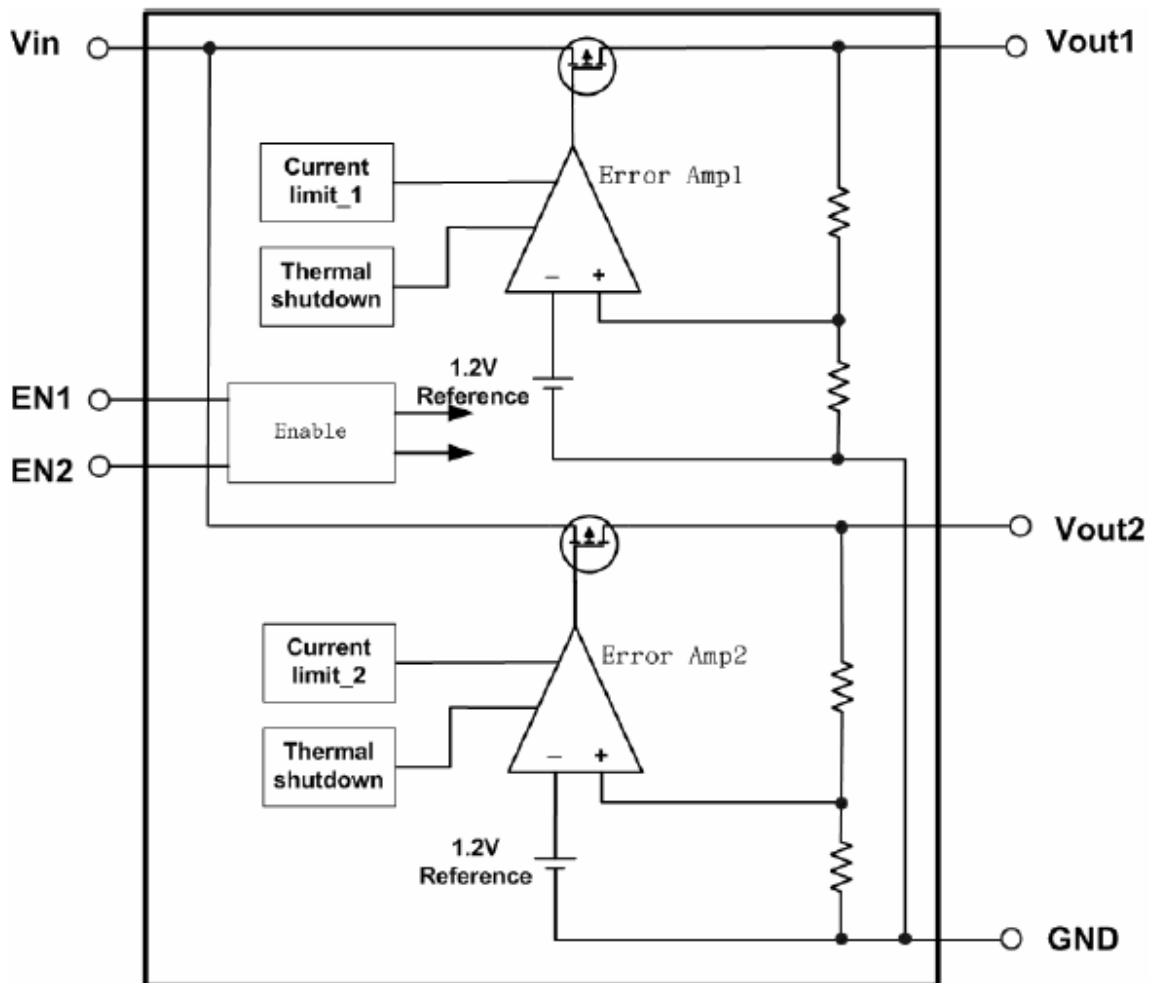

Absolute Maximum Ratings

Supply Input Voltage	-----6V
Power Dissipation, PD @ TA = 25° C	
SOT23-6	-----455mW
Package Thermal Resistance	
SOT23-6, θ_{JA}	-----220°C/W
Lead Temperature (Soldering, 10 sec.)	-----260°C
Storage Temperature Range	----- -65°C to 150°C
ESD Susceptibility	
HBM (Human Body Mode)	-----2kV
MM(Machine-Mode)	-----200V
Recommended Operating Conditions	
Operation Junction Temperature Range	----- -40°C to 125°C
Operation Ambient Temperature Range	----- -40°C to 85°C

Electrical Characteristics

(VIN = VOUT + 1V, CIN = COUT = 1 μ F, TA = 25° C, unless otherwise specified)

Parameter	Symbol	Test Conditions	Min	Typ	Max	Units
Output Voltage Accuracy	ΔV_{OUT}	IOUT = 1mA	-2	--	+2	%
Maximum output Current	I _{max}	Continuous	150	250		mA
Current Limit	I _{LIM}	RLOAD = 1 Ω	360	400	700	mA
Quiescent Current	I _Q	VEN \geq 1.2V, IOUT = 0mA		75	110	μ A
Dropout Voltage	V _{DROP}	IOUT = 30mA, VOUT > 2.8V		30	45	mV
		IOUT = 150mA, VOUT > 2.8V		80	150	
Line Regulation	ΔV_{LINE}	VIN = (VOUT + 1V) to 5.5V, IOUT = 1mA			0.3	%
Load Regulation	ΔV_{LOAD}	1mA < IOUT < 300mA			0.6	%
Standby Current	I _{STBY}	VEN = GND, Shutdown		0.01	1	μ A
EN Input Bias Current	I _{I_{BSD}}	VEN = GND or VIN		0	100	nA
EN Threshold	Logic-Low Voltage	V _{IL}			0.4	V
	Logic-High Voltage	V _{IH}	1.2			
Output Noise Voltage		10Hz to 100kHz, IOUT = 200mA COUT = 1 μ F		100		μ VRMS
Power Supply Rejection Rate	f = 100Hz f = 10kHz	PSRR		-75		dB
		COUT = 1 μ F, IOUT = 10mA		-65		
Thermal Shutdown Temperature	TSD			165		°C

Typical Operating Characteristics

Output Voltage vs. Temperature

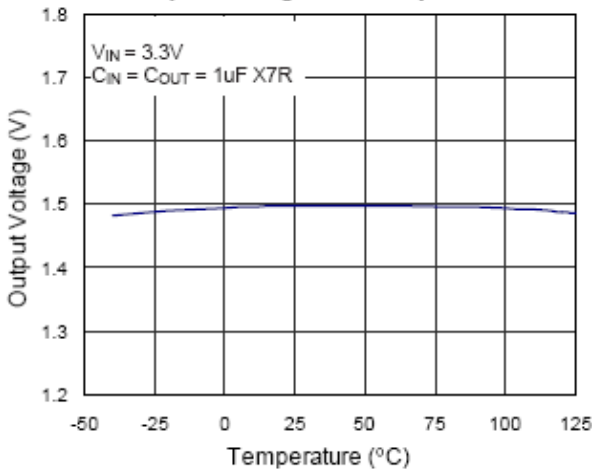

Quiescent Current vs. Temperature

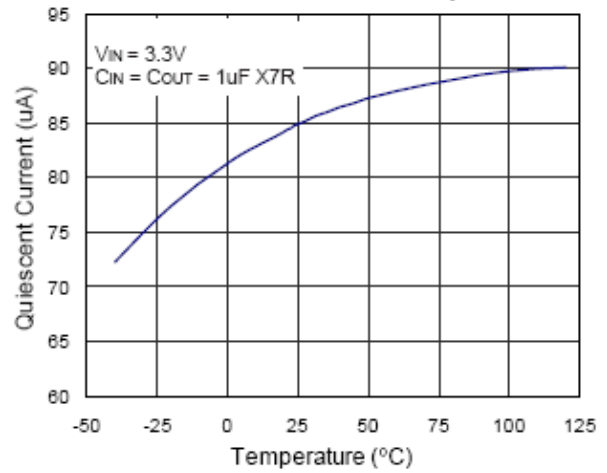

Dropout Voltage vs. Load Current

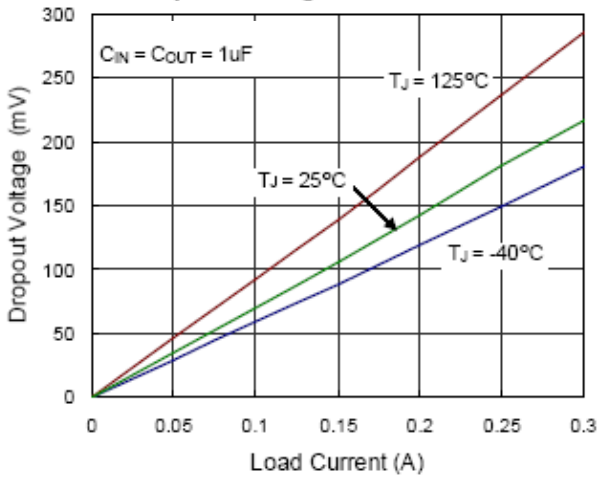

PSRR

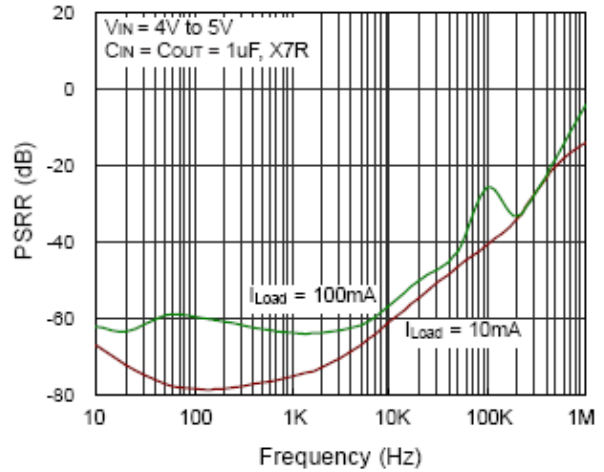

EN Pin Shutdown Threshold vs. Temperature

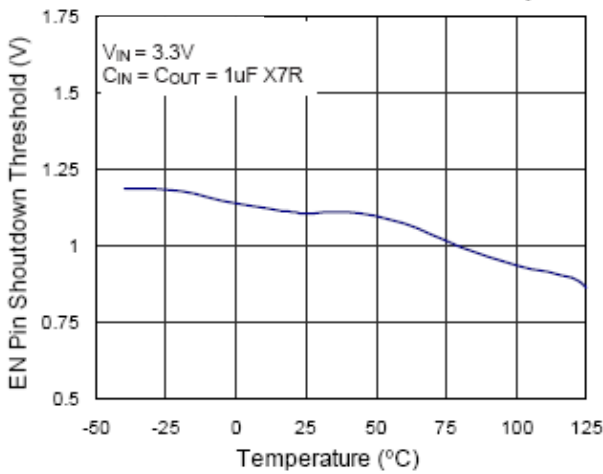

EN Pin Shutdown Response

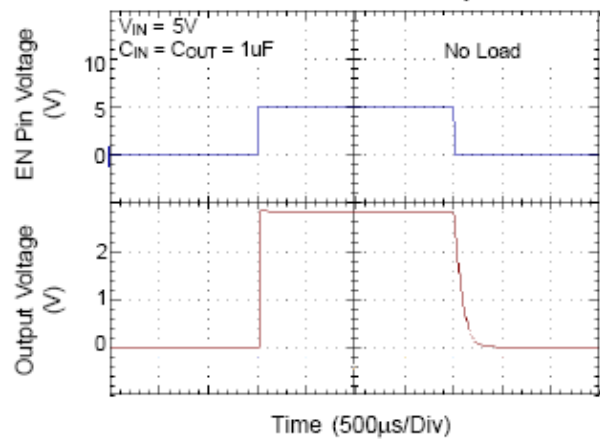

Load Transient Response

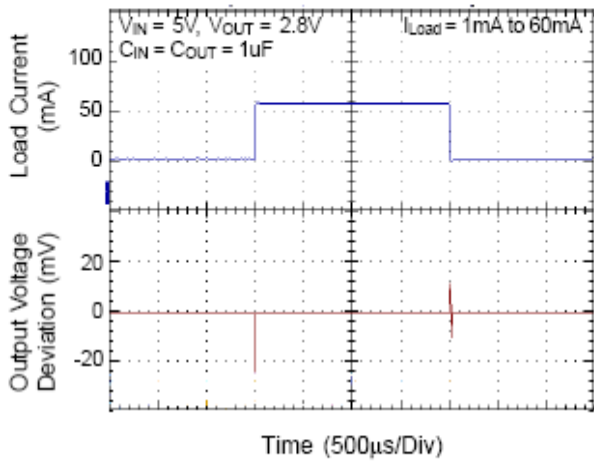

Load Transient Response

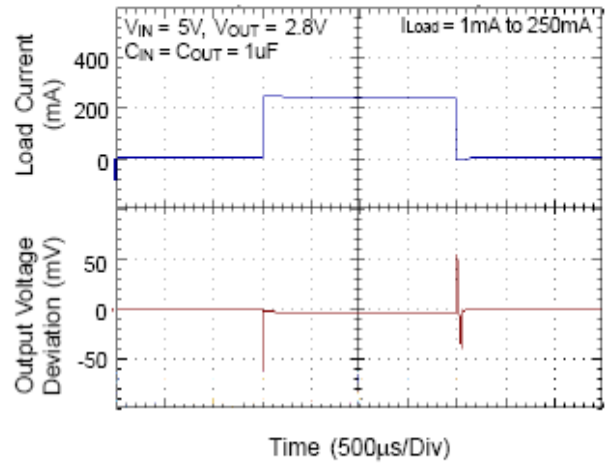

Line Transient Response

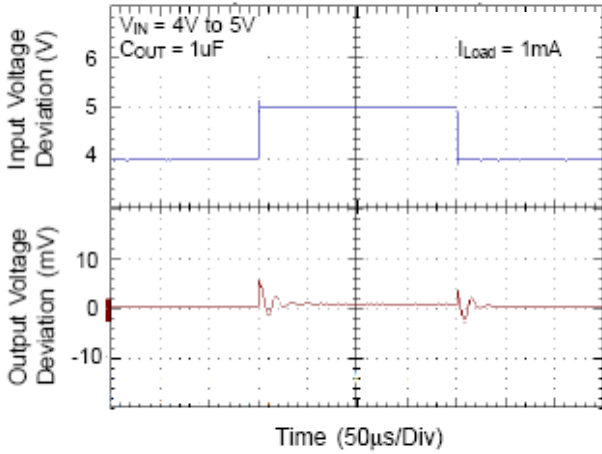

Line Transient Response

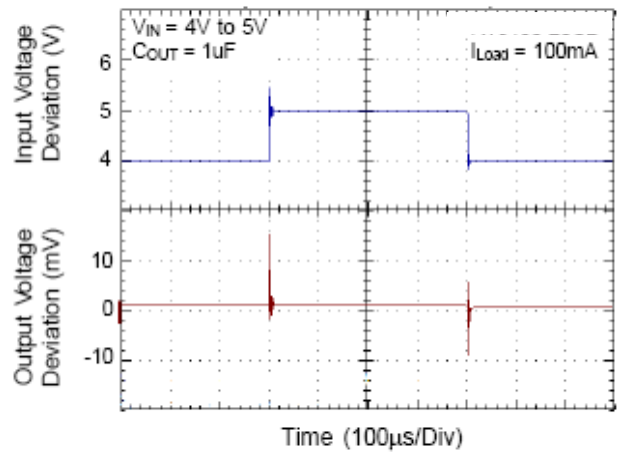

Noise

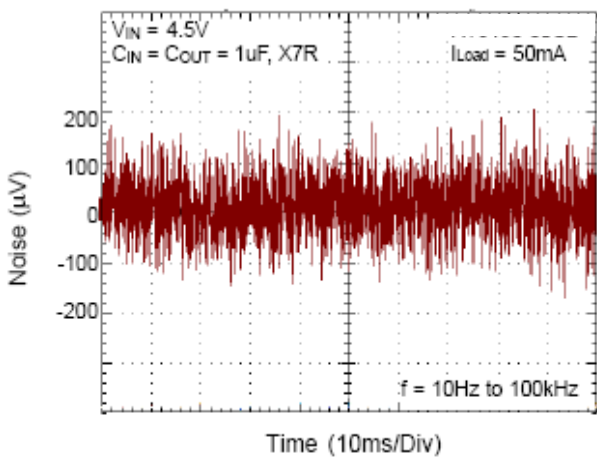

Noise

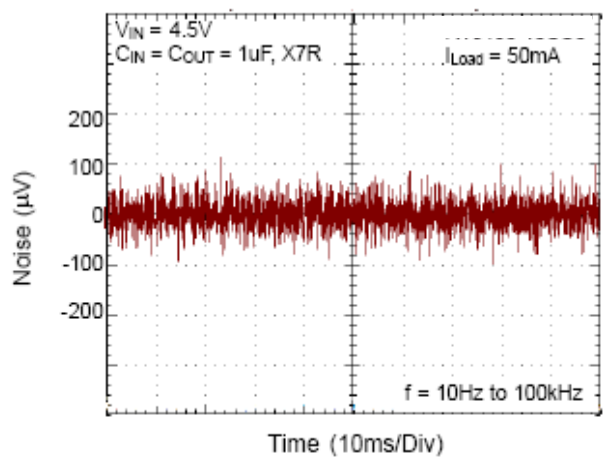

Applications Information

Like any low-dropout regulator, the external capacitors used with the LP2201 must be carefully selected for regulator stability and performance. Using a capacitor whose value is $> 1\mu\text{F}$ on the LP2201 input and the amount of capacitance can be increased without limit. The input capacitor must be located a distance of not more than 0.5 inch from the input pin of the IC and returned to a clean analog ground. Any good quality ceramic or tantalum can be used for this capacitor. The capacitor with larger value and lower ESR (equivalent series resistance) provides better PSRR and line-transient response. The output capacitor must meet both requirements for minimum amount of capacitance and ESR in all LDOs application. The LP2201 is designed specifically to work with low ESR ceramic output capacitor in space-saving and performance consideration. Using a ceramic capacitor whose value is at least $1\mu\text{F}$ with ESR is $> 25\text{m}\Omega$ on the LP2201 output ensures stability. The LP2201 still works well with output capacitor of other types due to the wide stable ESR range. Figure 1 shows the curves of allowable ESR range as a function of load current for various output capacitor values. Output capacitor of larger capacitance can reduce noise and improve load transient response, stability, and PSRR. The output capacitor should be located not more than 0.5 inch from the VOUT pin of the LP2201 and returned to a clean analog ground.

Start-up Function Enable Function

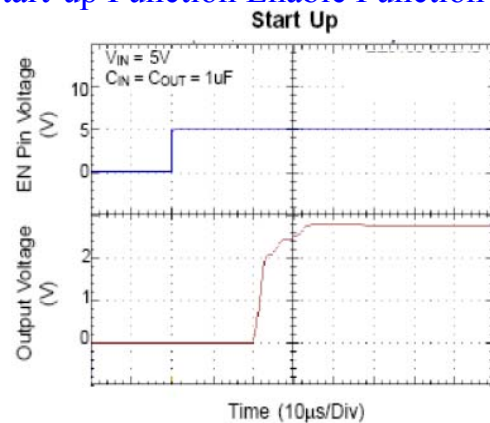

The LP2201 features an LDO regulator enable/disable function. To assure the LDO regulator will switch on, the EN turn on control level must be greater than 1.2 volts. The LDO regulator will go into the shutdown mode when the voltage on the EN pin falls below 0.4 volts. For protecting the system, the LP2201 have a quick-discharge function. If the enable function is not needed in a specific application, it may be tied to VIN to keep the LDO regulator in a continuously on state.

Thermal Considerations

Thermal protection limits power dissipation in LP2201. When the operation junction temperature exceeds 165°C , the OTP circuit starts the thermal shutdown function turn the pass element off. The pass element turn on again after the junction temperature cools by 30°C . For continue operation, do not exceed absolute maximum operation junction temperature 125°C .

The power dissipation definition in device is :

$$PD = (V_{IN} - V_{OUT}) \times I_{OOUT} + V_{IN} \times I_Q$$

The maximum power dissipation depends on the thermal resistance of IC package, PCB layout, the rate of surroundings airflow and temperature difference between junction to ambient.

The maximum power dissipation can be calculated by following formula :

$$PD(\text{MAX}) = (T_J(\text{MAX}) - T_A) / \theta_{JA}$$

Where $T_J(\text{MAX})$ is the maximum operation junction

temperature 125°C, T_A is the ambient temperature and the θ_{JA} is the junction to ambient thermal resistance. For recommended operating conditions specification of LP2201, where $T_{J(MAX)}$ is the maximum junction temperature of the die (125°C) and T_A is the maximum ambient temperature. The junction to ambient thermal resistance (θ_{JA} is layout dependent) for SOT23-6 package is 250°C/W.

$$PD(MAX) = (125^{\circ}C - 25^{\circ}C) / 250 = 400mW \text{ (SOT23-6)}$$

$$PD(MAX) = (125^{\circ}C - 25^{\circ}C) / 165 = 606mW$$

The maximum power dissipation depends on operating ambient temperature for fixed $T_{J(MAX)}$ and thermal resistance θ_{JA} .

Packaging Information

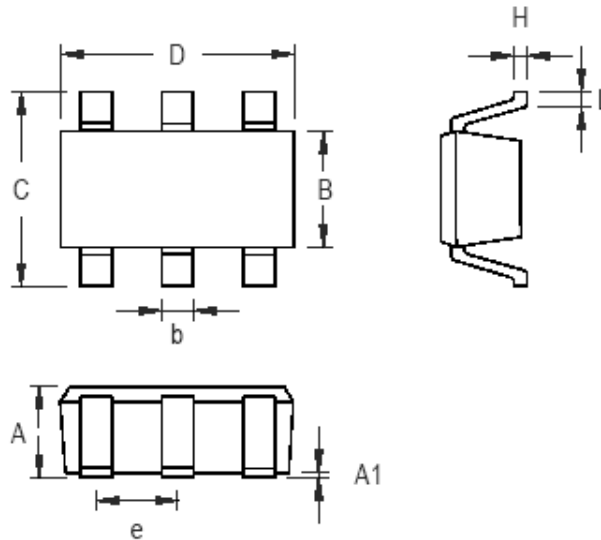

Symbol	Dimensions In Millimeters		Dimensions In Inches	
	Min	Max	Min	Max
A	0.889	1.295	0.031	0.051
A1	0.000	0.152	0.000	0.006
B	1.397	1.803	0.055	0.071
b	0.250	0.560	0.010	0.022
C	2.591	2.997	0.102	0.118
D	2.692	3.099	0.106	0.122
e	0.838	1.041	0.033	0.041
H	0.080	0.254	0.003	0.010
L	0.300	0.610	0.012	0.024

SOT-23-6 Surface Mount Package